

Self Diagnosis
Supported model

SERVICE MANUAL

AE-6B CHASSIS

MODEL	COMMANDER	DEST	CHASSIS NO.	MODEL	COMMANDER	DEST	CHASSIS NO.
KV-28LS60B	RM-932	FR	SCC-Q83C-A	KV-32LS60B	RM-932	FR	SCC-Q83B-A
KV-28LS60E	RM-932	ESP	SCC-Q81E-A	KV-32LS60E	RM-932	ESP	SCC-Q81D-A
KV-28LS60U	RM-932	UK	SCC-Q84D-A	KV-32LS60K	RM-932	OIRT	SCC-Q82C-A
				KV-32LS60U	RM-932	UK	SCC-Q84C-A

FD Trinitron



KV-28/32LS60



RM-932

TRINITRON[®] COLOR TV
SONY[®]

TABLE OF CONTENTS

Section	Title	Page	Section	Title	Page
	Caution	3			
	Specifications	4			
	Connectors	6			
	Self Diagnostic Software	7			
1. GENERAL			5. DIAGRAMS		
	Switching On the TV and Automatically Tuning	8	5-1.	Block Diagrams (1)	25
	Introducing the Menu System	9		Block Diagrams (2)	26
	Menu Guide	9		Block Diagrams (3)	27
	Teletext	11		Block Diagrams (4)	28
	Remote Control Configuration for VCR/DVD	11	5-2.	Circuit Board Location	28
	Specifications	12	5-3.	Schematic Diagrams and Printed Wiring Boards	28
	Troubleshooting	12		* A Board Schematic	29
2. DISASSEMBLY				* A Board PWB	31
	2-1. Rear Cover Removal	13		* VM Board Schematic.....	35
	2-2. Speaker Disconnection	13		* VM Board PWB	33
	2-3. Chassis Removal	13		* F2 Board Schematic	35
	2-4. Service Position	14		* F2 Board PWB	36
	2-5. D and G Board Removal	14		* H2 Board Schematic	35
	2-6. Side Control Module Removal	14		* H2 Board PWB	36
	2-7. H2 Board Removal	14		* G Board Schematic	37
	2-8. M Board Removal	15		* G Board PWB	36
	2-9. Service Connector for M Board.....	15	5-4.	Semiconductors	44
	2-10. Wire Dressing	15	5-5.	IC Blocks	47
	2-11. Picture Tube Removal	16			
	Bottom Plates	17	6. EXPLODED VIEWS		
3. SET-UP ADJUSTMENTS				6-1. Chassis	49
	3-1. Beam Landing	18		6-2. Picture Tube	50
	3-2. Convergence	19	7. ELECTRICAL PARTS LIST		51
	3-3. Focus Adjustment	21			
	3-4. Screen (G2), White Balance	21			
4. CIRCUIT ADJUSTMENTS					
	4-1. Electrical Adjustments	22			
	4-2. Test Mode 2	24			

CAUTION

SHORT CIRCUIT THE ANODE OF THE PICTURE TUBE AND THE ANODE CAP TO THE METAL CHASSIS, CRT SHIELD, OR THE CARBON PAINTED ON THE CRT, AFTER REMOVAL OF THE ANODE CAP.

WARNING !!

AN ISOLATION TRANSFORMER SHOULD BE USED DURING ANY SERVICE WORK TO AVOID POSSIBLE SHOCK HAZARD DUE TO LIVE CHASSIS, THE CHASSIS OF THIS RECEIVER IS DIRECTLY CONNECTED TO THE POWER LINE.

SAFETY-RELATED COMPONENT WARNING !!

COMPONENTS IDENTIFIED BY SHADING AND MARKED Δ ON THE SCHEMATIC DIAGRAMS, EXPLODED VIEWS AND IN THE PARTS LIST ARE CRITICAL FOR SAFE OPERATION. REPLACE THESE COMPONENTS WITH SONY PARTS WHOSE PART NUMBERS APPEAR AS SHOWN IN THIS MANUAL OR IN SUPPLEMENTS PUBLISHED BY SONY.

ATTENTION

APRES AVOIR DECONNECTE LE CAP DE L'ANODE, COURT-CIRCUITER L'ANODE DU TUBE CATHODIQUE ET CELUI DE L'ANODE DU CAP AU CHASSIS METALLIQUE DE L'APPAREIL, OU AU COUCHE DE CARBONE PEINTE SUR LE TUBE CATHODIQUE OU AU BLINDAGE DU TUBE CATHODIQUE.

ATTENTION !!

AFIN D'EVITER TOUT RISQUE D'ELECTROCUTION PROVENANT D'UN CHÂSSIS SOUS TENTION, UN TRANSFORMATEUR D'ISOLEMENT DOIT ETRE UTILISÉ LORS DE TOUT DÉPANNAGE LE CHÂSSIS DE CE RÉCEPTEUR EST DIRECTMENT RACCORDÉ À L'ALIMENTATION SECTEUR.

ATTENTION AUX COMPOSANTS RELATIFS À LA SECURITÉ!!

LES COMPOSANTS IDENTIFIÉS PAR UNE TRAME ET PAR UNE MARQUE Δ SUR LES SCHÉMAS DE PRINCIPE, LES VUES EXPLOSÉES ET LES LISTES DE PIÈCES SONT D'UNE IMPORTANCE CRITIQUE POUR LA SÉCURITÉ DU FONCTIONNEMENT, NE LES REMPLACER QUE PAR DES COMPOSANTS SONY DONT LE NUMÉRO DE PIÈCE EST INDICÉ DANS LE PRÉSENT MANUEL OU DANS DES SUPPLÉMENTS PUBLIÉS PAR SONY.

CAUTION

Lead Free Soldered Boards

The circuit boards listed below [Table 1] used in these models may have been processed using Lead Free Solder. The boards are identified by the LF logo located close to the board designation e.g. F1, H1 etc [see examples]. The servicing of these boards requires special precautions to be taken as outlined below.



Table 1

Board	Function
C	R,G,B Out
F2	Power Switch/Fuse
H2	Front AV/ Headphone

example 1

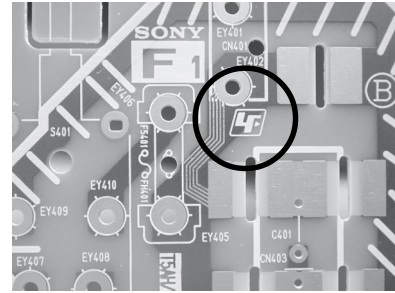

example 2

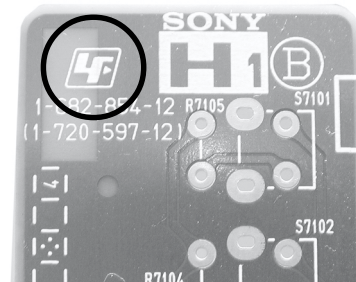

It is strongly recommended to use Lead Free Solder material in order to guarantee optimal quality of new solder joints. Lead Free Solder is available under the following part numbers :

Partnumber	Diameter	Remarks
7-640-005-19	0.3mm	0.25Kg
7-640-005-20	0.4mm	0.50Kg
7-640-005-21	0.5mm	0.50Kg
7-640-005-22	0.6mm	0.25Kg
7-640-005-23	0.8mm	1.00Kg
7-640-005-24	1.0mm	1.00Kg
7-640-005-25	1.2mm	1.00Kg
7-640-005-26	1.6mm	1.00Kg

Due to the higher melting point of Lead Free Solder the soldering iron tip temperature needs to be set to 370 degrees centigrade. This requires soldering equipment capable of accurate temperature control coupled with a good heat recovery characteristics.

For more information on the use of Lead Free Solder, please refer to <http://www.sony-training.com>

ITEM MODEL	Television System	Stereo System	Channel Coverage	Color System
B	B/G/H, D/K, I, L	GERMAN/NICAM Stereo	VHF : E2-E12, F2-F10 UHF : E21-E69, F21-F69, B21-B69 CABLE TV : S01-S03, S1-S20, B-Q HYPER : S21-S41	PAL, SECAM NTSC4.43, NTSC3.58 (VIDEO IN)
E	B/G/H	GERMAN/NICAM Stereo	VHF : E2-E12 UHF : E21-E69 CABLE TV : S01-S03, S1-S20 HYPER : S21-S41	PAL, SECAM NTSC4.43, NTSC3.58 (VIDEO IN)
K	B/G/H, D/K	GERMAN/NICAM Stereo	VHF : E2-E12, R01-R12 UHF : E21-E69, R21-R69 CABLE TV : S01-S03, S1-S20 HYPER : S21-S41	PAL, SECAM NTSC4.43, NTSC3.58 (VIDEO IN)
U	I	NICAM Stereo	I UHF : E21-E69	PAL, SECAM NTSC4.43, NTSC3.58 (VIDEO IN)

Picture Tube	Flat Display FD Trinitron Approx 71 cm (28 inches) (Approx 66 cm picture measured diagonally) KV-28LS60 Approx 82 cm (32 inches) (Approx 76 cm picture measured diagonally) KV-32LS60	Sound output	
		Right and Left speaker	2x20W (Music Power) 2x10W (RMS)
		Sub Woofer	1x30W (Music Power) 1x15W (RMS)
Input/Output Terminals [REAR]		General Specifications	
1: 21-pin Euro connector (CENELEC standard)	Inputs for Audio and Video signals. Inputs for RGB. Outputs of TV Video and Audio signals.	Power Requirements	220 - 240V
2: 21-pin Euro connector	Inputs for Audio and Video signals. Inputs for S Video. Outputs of TV Video and Audio signals. (selectable)	Power Consumption	90 W (KV-28LS60) 88 W (KV-32LS60)
3: 21-pin Euro connector	Inputs for Audio and Video signals. Inputs for S Video. Outputs of TV Video and Audio signals. (Monitor Out)	Dimensions	Approx 806x497x540mm (KV-28LS60) Approx 891x564x584mm (KV-32LS60)
Phono Jacks	Output Connectors variable for Audio Signals	Weight	Approx 43kg (KV-28LS60) Approx 60.5kg (KV-32LS60)
		Supplied Accessories	RM-932 Remote Commander (1) IEC designated R6 battery (2)
		Other Features	100 Hz picture, TV system Autodetection, Teletext, Smartlink, BBE, Virtual Dolby
Input/Output Terminals [SIDE]		Remote Control System : Infrared Control	
Headphone jack	stereo mini jack	Power requirements	3V dc 2 batteries IEC designation R6 (size AA)
Audio inputs	phono jacks		
Video inputs	phono jacks		
S Video input	4 pin DIN		
Design and specifications are subject to change without notice.			

Model Name Item	KV-28LS60B ~ KV-32LS60B	KV-28LS60E ~ KV-32LS60E	KV-32LS60K	KV-28LS60U ~ KV-32LS60U
Pal Comb	OFF	OFF	OFF	OFF
PIP	OFF	OFF	OFF	OFF
RGB Priority	ON	ON	ON	ON
Woofers Box	ON	ON	ON	ON
Scart 1	ON	ON	ON	ON
Scart 2	ON	ON	ON	ON
Front in (3)	ON	ON	ON	ON
Scart 4	OFF	OFF	OFF	OFF
Projector	OFF	OFF	OFF	OFF
Norm B/G	ON	ON	ON	OFF
Norm I	ON	OFF	OFF	ON
Norm D/K	ON	ON	ON	OFF
Norm AUS	OFF	OFF	OFF	OFF
Norm L	ON	OFF	OFF	OFF
Norm SAT	OFF	OFF	OFF	OFF
Norm M	OFF	OFF	OFF	OFF
Teletext	ON	ON	ON	ON
Nicam Stereo	ON	ON	ON	ON

WARNING (UK Models only)

The flexible mains lead is supplied connected to a **B.S. 1363** fused plug having a fuse of **5 AMP** rating. Should the fuse need to be replaced, use a **5 AMP FUSE** approved by ASTA to **BS 1362**, ie one that carries the  mark.

IF THE PLUG SUPPLIED WITH THIS APPLIANCE IS NOT SUITABLE FOR THE OUTLET SOCKETS IN YOUR HOME, IT SHOULD BE CUT OFF AND AN APPROPRIATE PLUG FITTED. THE PLUG SEVERED FROM THE MAINS LEAD MUST BE DESTROYED AS A PLUG WITH BARED WIRES IS DANGEROUS IF ENGAGED IN A LIVE SOCKET.

When an alternative type of plug is used, it should be fitted with a **5 AMP FUSE**, otherwise the circuit should be protected by a **5 AMP FUSE** at the distribution board.

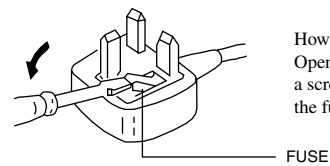

How to replace the fuse.
Open the fuse compartment with a screwdriver blade and replace the fuse.

21 pin connector

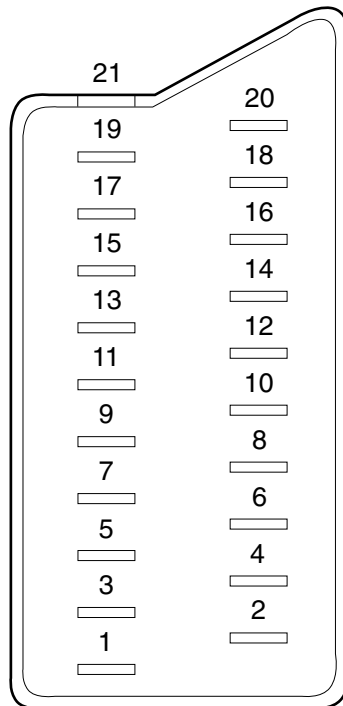

Pin No	1	2	3	Signal	Signal level
1	○	○	○	Audio output B (right)	Standard level : 0.5V rms Output impedance : Less than 1kohm*
2	○	○	○	Audio input B (right)	Standard level : 0.5V rms Output impedance : More than 10kohm*
3	○	○	○	Audio output A (left)	Standard level : 0.5V rms Output impedance : Less than 1kohm*
4	○	○	○	Ground (audio)	
5	○	○	○	Ground (blue)	
6	○	○	○	Audio input A (left)	Standard level : 0.5V rms Output impedance : More than 10kohm*
7	○	●	●	Blue input	0.7 +/- 3dB, 75 ohms positive
8	○	○	○	Function select (AV control)	High state (9.5-12V) : Part mode Low state (0-2V) : TV mode Input impedance : More than 10K ohms Input capacitance : Less than 2nF
9	○	○	○	Ground (green)	
10	○	○	○	Open	
11	○	●	●	Green	Green signal : 0.7 +/- 3dB, 75 ohms, positive
12	○	○	○	Open	
13	○	○	○	Ground (red)	
14	○	○	○	Ground (blanking)	
15	○	-	-	Red input	0.7 +/- 3dB, 75 ohms, positive
	-	○	○	(S signal Chroma input)	0.3 +/- 3dB, 75 ohms, positive
16	○	●	●	Blanking input (Ys signal)	High state (1-3V) Low state (0-0.4V) Input impedance : 75 ohms
17	○	○	○	Ground (video output)	
18	○	○	○	Ground (video input)	
19	○	○	○	Video output	1V +/- 3dB, 75ohms, positive sync 0.3V (-3+10dB)
20	○	-	-	Video input	1V +/- 3dB, 75ohms, positive sync 0.3V (-3+10dB)
	-	○	○	Video input Y (S signal)	1V +/- 3dB, 75ohms, positive sync 0.3V (-3+10dB)
21	○	○	○	Common ground (plug, shield)	

○ Connected ● Not Connected (open) * at 20Hz - 20kHz

Rear Connection Panel

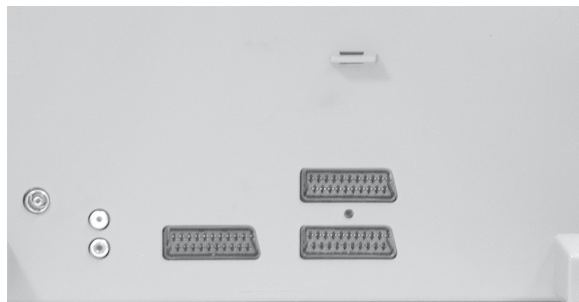

Front Connection Panel



S-Video socket

S Video socket pin configuration		
Pin No	Signal	Signal Level
1	Ground	-
2	Ground	-
3	Y (S signal) input	1V +/- 3dB 75ohm, positive Sync. 0.3V -3 +10dB
4	C (S signal) input	0.3V +/- 3dB 75ohm, positive Sync.

AE-6B SELF DIAGNOSTIC SOFTWARE

The identification of errors within the AE-6B chassis is triggered in one of two ways :- 1: Busy or 2: Device failure to respond to IIC. In the event of one of these situations arising the software will first try to release the bus if busy (Failure to do so will report with a continuous flashing LED) and then communicate with each device in turn to establish if a device is faulty. If a device is found to be faulty the relevant device number will be displayed through the LED (Series of flashes which must be counted) See table 1, non fatal errors are reported using this method.

Each time the software detects an error it is stored within the NVM. See Table 2.

Table 1

Error Message	LED Code
No error	00
Reserved	01
OCP (Over Current Protection)	02
Over Voltage Protection	03
No Vertical Sync	04
IKR Error at power on	05
IIC bus clock and/or data lines low at power on	06
NVM no IIC bus acknowledge at power on	07
Horizontal Protection	08
Tuner no acknowledge at power on	09
Sound Processor Error	10
Reserved	11
Scanrate Error	12
DAC Error	13
Backend Error	14
Dynamic Convergence Error	15
PIP Error	16

Flash Timing Example : e.g. error number 3

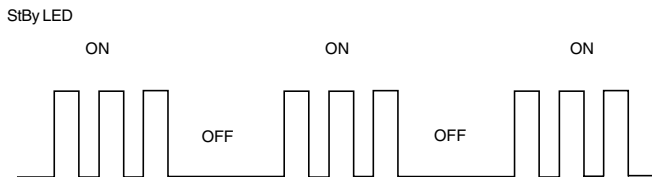

How to enter into Table 2

1. Turn on the main power switch of the TV set.
2. Program Remote Commander for Operation in Service Mode. [See Page 22].
3. Press 'VIDEO' 'VIDEO' > 'MENU' on the Remote Commander.
4. Using the Remote Commander, Scroll to the 'Error Menu' item using the down arrow key, then press the right arrow key.
5. The following table will be displayed indicating the error count.

Table 2



ERROR MENU			
E02	OCP	(0, 255)	0
E03	OVP	(0, 255)	0
E04	VSYNC	(0, 255)	0
E05	IKR	(0, 255)	0
E06	IIC	(0, 255)	0
E07	NVM	(0, 255)	0
E08	HPROT	(0, 255)	0
E09	TUNER	(0, 255)	0
E10	SOUNDP	(0, 255)	0
E11	-	(0, 255)	0
E12	SCANRATE	(0, 255)	0
E13	DAC	(0, 255)	0
E14	BACKEND	(0, 255)	0
E15	DYN CON	(0, 255)	0
E16	PIP	(0, 255)	0
WORKING TIME			
HOURS			14
MINUTES			7

Note: To clear the error count data press '80' on the Remote commander.

The operating instructions mentioned here are partial abstracts from the 'Operating Instruction Manual'. The page numbers of the 'Operating Instruction Manual' remain as in the manual.

Switching On the TV and Automatically Tuning

1 The first time you switch on your TV, a sequence of menu screens appear on the TV enabling you to: 1) choose the language of the menu screen, 2) choose the country in which you wish to operate the TV, 3) adjust the picture slant 4) search and store all available channels (TV Broadcast) and 5) change the order in which the channels (TV Broadcast) appear on the screen.



However, if you need to change any of these settings at a later date, you can do that by selecting the appropriate option in the  (Set Up menu) or by pressing the Auto Start Up Button  on the TV set.

1 Connect the TV plug to the mains socket (220-240V AC, 50Hz)

The first time that the TV set is connected, it is usually turned on. If the TV is off, press the  on/off button on the TV set to turn on the TV.

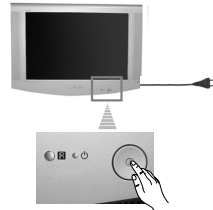

The first time you switch on the TV, a **Language** menu displays automatically on the TV screen.

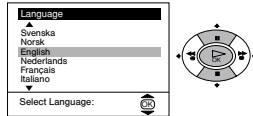

2 Press the  or  button on the remote control to select the language, then press the **OK** button to confirm your selection. From now on all the menus will appear in the selected language.



GB



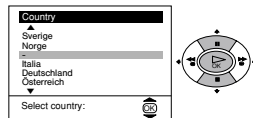



3 The **Country** menu appears automatically on the TV screen. Press the  or  button to select the country in which you will operate the TV set, then press the **OK** button to confirm your selection.

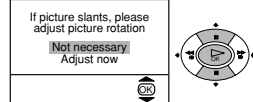

- i** • If the country in which you want to use the TV set does not appear in the list, select “-” instead of a country.
- In order to avoid teletext characters for Cyrillic languages we recommend to select Russia country in the case that your own country does not appear in the list.

4 Because of the earth's magnetism, the picture might slant. The **Picture Rotation** menu allows you to correct the picture slants if it is necessary.



- a) If it is not necessary, press  or  to select **Not necessary** and press **OK**.
- b) If it is necessary, press  or  to select **Adjust now**, then press **OK** and correct any slant of the picture between -5 and +5 by pressing  or . Finally press **OK** to store.

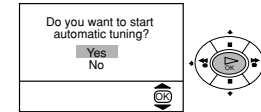

5 The Auto Tuning menu appears on the screen. Press the **OK** button to select **Yes**.

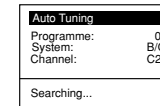

6 The TV starts to automatically search and store all available broadcast channels for you.

A This procedure could take some minutes. Please be patient and do not press any buttons, otherwise the automatic tuning will not be completed.



i In some countries is the TV Broadcaster who installs automatically the channels (ACI system). In this case, the TV Broadcaster sends a menu in which you can select your city by pressing the  or  button and **OK** to store the channels.



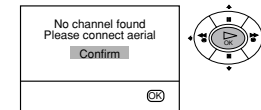



A If no channels were found during the auto tuning process then a new menu appears automatically on the screen asking you to connect the aerial. Please connect the aerial (see page 6) and press **OK**. The auto tuning process will start again.



7 **i** After all available channels are captured and stored, the **Programme Sorting** menu appears automatically on the screen enabling you to change the order in which the channels appear on the screen.

a) If you wish to keep the broadcast channels in the tuned order, go to step 8.

b) If you wish to store the channels in a different order:

- 1 Press the  or  button to select the programme number with the channel (TV Broadcast) you wish to rearrange, then press the  button.
- 2 Press the  or  button to select the new programme number position for your selected channel (TV Broadcast), then press .
- 3 Repeat steps b)1 and b)2 if you wish to change the order of the other channels.

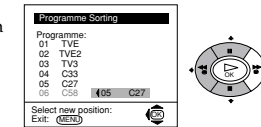
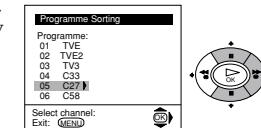

8 Press the **MENU** button to remove the menu from the screen.

MENU



 Your TV is now ready for use

continued...

Introducing and Using the Menu System

i Your TV uses an on-screen menu system to guide you through the operations. Use the following buttons on the Remote Control to operate the menu system:

1 Press the **MENU** button to switch the first level menu on.

MENU



2 To highlight the desired menu or option, press **↓** or **↑**.

- To enter to the selected menu or option, press **↵**.
- To return to the last menu or option, press **←**.
- To alter settings of your selected option, press **↓** / **↑** / **←** or **→**.
- To confirm and store your selection, press **OK**.

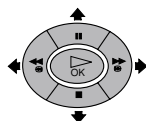

3 Press the **MENU** button to remove the menu from the screen.

MENU



GB

Menu Guide

Level 1

Level 2

Level 3 / Function

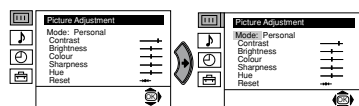

PICTURE ADJUSTMENT

The "Picture Adjustment" menu allows you to alter the picture adjustments.

To do this: after selecting the item you want to alter press **↵**, then press repeatedly **↓** / **↑** / **←** or **→** to adjust it and finally press **OK** to store the new adjustment.

This menu also allows you to customise the picture mode based on the programme you are watching:

- Live** (for live broadcast programmes, DVD and Digital Set Top Box receivers).
- Personal** (for individual settings).
- Movie** (for films).

- Brightness, Colour and Sharpness** can only be altered if "Personal" mode is selected.
- Hue** is only available for NTSC colour signal (e.g. USA video tapes).
- Select **Reset** and press **OK** to reset the picture to the factory preset levels.

Level 1

Level 2

Level 3 / Function

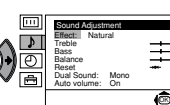
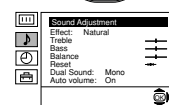
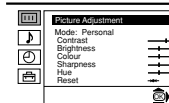

SOUND ADJUSTMENT

The "Sound Adjustment" menu allows you to alter the sound adjustments.

To do this: after selecting the item you want to alter, press **↵**. Then press repeatedly **↓** / **↑** / **←** or **→** to adjust it and finally press **OK** to store the new adjustment.

- Effect** **↵**
- Natural:** Enhances clarity, detail and presence of sound by using "BBE High Definition Sound system"*.
 - Dynamic:** "BBE High Definition Sound system"* intensifies clarity and presence of sound for better intelligibility and musical realism.
 - Dolby**Virtual:** Simulates the sound effect of "Dolby Surround Pro Logic".
 - Off:** Flat response.
- Treble** **↵** **←** Less **→** More
- Bass** **↵** **←** Less **→** More
- Balance** **↵** **←** Left **→** Right
- Reset** **⊗** Resets the sound to the factory preset levels.
- Dual Sound** **↵**
- For a stereo broadcast:
 - Mono.**
 - Stereo.**
 - For a bilingual broadcast:
 - Mono** (for mono channel if available).
 - A** (for channel 1).
 - B** (for channel 2).
- Auto Volume** **↵**
- Off:** volume level changes according to the broadcast signal.
 - On:** volume level of the channels will stay the same, independent of the broadcast signal (e.g. in the case of advertisements).

- If you are listening to the TV through headphones, the "Effect" option will automatically be switched to "Off".
- If you select "Dolby Virtual" on the "Effect" option, the "Auto Volume" option will automatically be switched to "Off" and vice versa.

i * The "BBE High Definition Sound system" is manufactured by Sony Corporation under license from BBE Sound, Inc. It is covered by U.S. Patent No. 4,638,258 and No. 4,482,866. The word "BBE" and BBE Symbol are trademarks of BBE Sound, Inc.

i ** This TV has been designed to create the "Dolby Surround" sound effect by simulating the sound of four speakers with two speakers, when the broadcast audio signal is Dolby Surround encoded. The sound effect can also be improved by connecting a suitable external amplifier (for details refer to "Connecting to external audio Equipment" on page 19).

** Manufactured under license from Dolby Laboratories. "Dolby", "Pro Logic" and the double-D symbol **DD** are trademarks of Dolby Laboratories.

continued...

Level 1

Level 2

Level 3 / Function

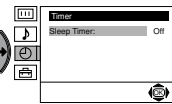
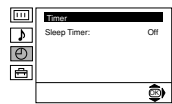
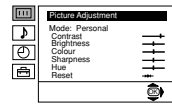

SLEEP TIMER

The "Sleep Timer" option in the "Timer" menu allows you to select a time period for the TV to switch itself automatically into the standby mode.

To do this: after selecting the option press **▶**, then press **▼** or **▲** to set the time period delay (max. of 4 hours).

- While watching the TV, you can press the **⏸** button on the remote control to display the time remaining.
- One minute before the TV switches itself into standby mode, the time remaining is displayed on the TV screen automatically.

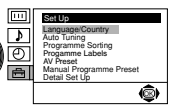
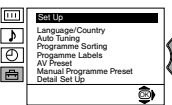
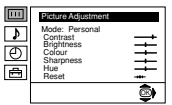

LANGUAGE / COUNTRY

The "Language/Country" option in the "Set Up" menu allows you to select the language that the menus are displayed in. It also allows you to select the country in which you wish to operate the TV set.

To do this: after selecting the option, press **▶** and then proceed in the same way as in the steps 2 and 3 of the section "Switching On the TV and Automatically Tuning" on page 7.

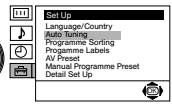
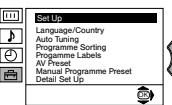
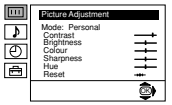

AUTO TUNING

The "Auto Tuning" option in the "Set Up" menu allows you to automatically search for and store all available TV channels.

To do this: after selecting the option, press **▶** and then proceed in the same way as in TV steps 5 and 6 of the section "Switching On the TV and Automatically Tuning" on page 8.

continued...

Level 1

Level 2

Level 3 / Function

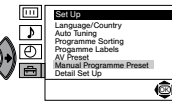
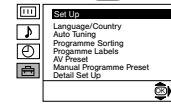
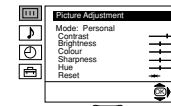

MANUAL PROGRAMME PRESET

The "Manual Programme Preset" option in the "Set Up" menu allows you to:

- 1) Preset channels or the VCR channel one by one to the programme order of your choice. To do this:
 - 1 After selecting the "Manual Programme Preset" option, press **▶** then with **Programme** option highlighted press **▶**. Press **▼** or **▲** to select on which programme number you want to preset the channel (for VCR, select programme number "0"). Then press **◀**.

- 2 **i** The following option is only available depending on the country you have selected in the "Language/Country" menu.

After selecting the **System** option, press **▶**. Then press **▼** or **▲** to select the TV Broadcast system (**B/G** for western European countries or **D/K** for eastern European countries). Then press **◀**.

- 3 After selecting the **Channel** option, press **▶**. Then press **▼** or **▲** to select the channel tuning ("**C**" for terrestrial channels or "**S**" for cable channels). Next press **▶**. After that, press the number buttons to enter directly the channel number of the TV Broadcast or the channel of the VCR signal. If you do not know the channel number, press **▼** or **▲** to search for it. When you tune the desired channel, press **OK** twice to store.

Repeat all the above steps to tune and store more channels.

- b) Label a channel using up to five characters. To do this: Highlighting the **Programme** option, press the **PROG +/-** button to select the programme number with the channel you wish to name. When the programme you want to name appears on the screen, select the **Label** option and press **▶**. Next press **▼** or **▲** to select a letter, number or "-" for a blank. Press **▶** to confirm this character. Select the other four characters in the same way. After selecting all the characters, press **OK** twice to store.

- c) Normally the automatic fine tuning (AFT) is operating, however you can manually fine tune the TV to obtain a better picture reception in the case that the picture is distorted.

To do this: while watching the channel (TV Broadcast) you wish to fine tune, select the **AFT** option and press **▶**. Next press **▼** or **▲** to adjust the fine tuning between -15 and +15. Finally press **OK** twice to store.

- d) Skip any unwanted programme numbers when they are selected with the **PROG +/-** buttons. To do this: Highlighting the **Programme** option, press the **PROG +/-** button to select the programme number you want to skip. When the programme you want to skip appears on the screen, select the **Skip** option and press **▶**. Next press **▼** or **▲** to select **Yes**. Finally press **OK** twice to confirm and store.

To cancel this function afterwards, select "No" instead of "Yes" in the step above.

- e) View and record correctly scrambling channels when using a decoder connected to the Scart **3/3** directly or through a VCR.

- i** This option is only available depending on the country you have selected in the "Language/Country" menu.

To do this: select the **Decoder** option and press **▶**. Next press **▼** or **▲** to select **On**. Finally press **OK** twice to confirm and store.

To cancel this function afterwards, select "Off" instead of "On" in the step above.

GB

GB

Teletext

i Teletext is an information service transmitted by most TV stations. The index page of the teletext service (usually page 100) gives you information on how to use the service. To operate teletext, use the remote control buttons as indicated below.

A Make sure to use a channel (TV Broadcast) with a strong signal, otherwise teletext errors may occur.

To Switch On Teletext :

After selecting the TV channel which carries the teletext service you wish to view, press .



To Select a Teletext page:

Input 3 digits for the page number, using the numbered buttons.

- If you have made a mistake, retype the correct page number.
- If the counter on the screen continues searching, it is because this page is not available. In that case, input another page number



To access the next or preceding page:

Press PROG + () or PROG - ()



To superimpose teletext on to the TV:

Whilst you are viewing teletext, press . Press it again to cancel teletext mode.



To freeze a teletext page:

Press  / . Press it again to cancel the freeze.

To reveal concealed information (e.g. answer to a quiz):

Press  / . Press it again to conceal the information.

To select a sub page:

A teletext page may consist of several sub pages. In this case the page number that appears on the upper left corner will become from white to green colour and one or more arrows will appear next to the page number. Press repeatedly  or  buttons on the remote control to watch the desired sub page.

To Switch Off Teletext:

Press .

Fastext

i Fastext service lets you access pages with one button push.

While you are in Teletext mode and Fastext is broadcast, a colour coded menu appears at the bottom of the teletext page. Press the colour button (red, green, yellow or blue) to access the corresponding page.

Remote Control Configuration for VCR/DVD

This remote control is default to operate basic functions of this Sony TV, Sony DVD and most of Sony VCR when batteries are initially installed. To control other VCR and DVD major brands and some Sony VCR models, please complete the following steps:

i Before you start, look up the 3 digit code for your brand of DVD or VCR from the list below. On those brands that have more than one code, enter the first code number.

- Sony will endeavour to update the software according to market changes. Therefore, please refer to code table included with the remote control for latest code set.

1 Press the Media Selector button on the remote control repeatedly until the required VCR or DVD green light is lit.

A If Media Selector is on TV position, code numbers will not be stored.

2 Before the green light goes out, press and hold the yellow button for approximately 6 seconds until the green light starts flashing.

3 Whilst the green light is flashing, enter all three digits of the code for your brand using the number buttons on the remote control.

i If your selected code is entered correctly, all three green lights will be lit momentarily.

4 Turn on your brand VCR or DVD and check that the main functions work.

A If your device is not working or some of the functions do not work please check you entered the correct code set or try the next code listed against the brand.

- Your brand codes may be lost if weak batteries are not replaced within a few minutes. To reset your brand DVD or VCR please repeat the above steps. A small label is added inside the battery door to allow you to record your brand codes.

- Not all brands are covered and not all models of every brand may be covered.

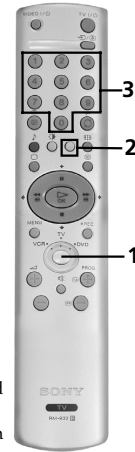

GB

VCR Brand List

Brand	Code
SONY (VHS)	301, 302, 303, 308, 309
SONY (BETA)	303, 307, 310
SONY (DV)	304, 305, 306
AIWA	325, 331, 351
AKAI	326, 329, 330
DAEWOO	342, 343
GRUNDIG	358, 355, 360, 361, 320, 351
HITACHI	327, 333, 334
JVC	314, 315, 322, 344, 352, 353, 354, 348, 349
LG	332, 338
LOEWE	358, 355, 360, 361, 320, 351
MATSUI	356, 357
ORION	328
PANASONIC	321, 323
PHILIPS	311, 312, 313, 316, 317, 318, 358, 359
SAMSUNG	339, 340, 341, 345
SANYO	335, 336
SHARP	324
THOMSON	319, 350
TOSHIBA	337

DVD Brand List

Brand	Code
SONY	001
AIWA	021
DENON	018, 027, 020, 002
GRUNDIG	009, 028, 023, 024, 016, 003
HITACHI	025, 026, 015, 004
JVC	006, 017
KENWOOD	008
LG	015, 014
LOEWE	009, 028, 023, 024, 016, 003
MATSUI	013, 016
ONKYO	022
PANASONIC	018, 027, 020, 002
PHILIPS	009, 028, 023, 024, 016, 003
PIONEER	004
SAMSUNG	011, 014
SANYO	007
SHARP	019, 027
THOMSON	012
TOSHIBA	003
YAMAHA	018, 027, 020, 002

Specifications

TV system:

Depending on your country selection:
B/G/H, D/K

Colour system:

PAL, SECAM
NTSC 3.58, 4.43 (only Video In)







Channel Coverage:

VHF: E2-E12
UHF: E21-E69
CATV: S1-S20
HYPER: S21-S41
D/K: R1-R12, R21-R69





Picture Tube:

Flat Display FD Trinitron WIDE
32" (approx. 82 cm. measured
diagonally)

Rear Terminals

-  1 /  1 21-pin scart connector (CENELEC standard) including audio/video input, RGB input, TV audio/video output.
-  2 /  2 21-pin Scart connector (CENELEC standard) including audio / video input, RGB input, monitor audio/video output.
-  3 /  3 (SMARTLINK) 21-pin Scart connector (CENELEC standard) including audio / video input, S video input, selectable audio / video output and Smartlink interface.
-  audio outputs (Left/Right) - phono jacks

Side Terminals

-  4 S Video input - 4 pin DIN
-  4 video input - phono jack
-  4 audio input - phono jacks
-  headphones jack

Sound Output:

2 x 20 W (music power)
2 x 10 W (RMS)

Woofers:

30 W (music power)
15 W (RMS)

Power Consumption:

130 W

Standby Power Consumption:

0.3 W

Dimensions (w x h x d) :

Approx. 891 x 504 x 584 mm.

Weight:

Approx. 62.2 Kg.

Accessories supplied:

- 1 Remote Control (RM-932)
- 2 Batteries (IEC designated)











Other features:

- 100 Hz picture
- Teletext, Fasttext, TOPtext (250 page TEXT memory)
- Sleep Timer
- Smartlink (direct link between your TV set and a compatible VCR. For more information on Smartlink, please refer to the Instruction Manual of your VCR).
- TV system Autodetection.
- Dolby Virtual.
- BBE.
- Auto Format.
- ACI (Auto Channel Installation).

GB

Troubleshooting

 Here are some simple solutions to the problems which may affect the picture and sound.

Problem	Solution
No picture (screen is dark) and no sound.	<ul style="list-style-type: none"> • Check the aerial connection. • Plug the TV in and press the  button on the front of the TV. • If the standby indicator  is on, press TV  button on the remote control.
Poor or no picture (screen is dark), but good sound.	<ul style="list-style-type: none"> • Using the menu system, select the "Picture Adjustment" menu and select "Reset" to return to the factory settings.
No picture or no menu information from equipment connected to the Scart connector.	<ul style="list-style-type: none"> • Check that the optional equipment is on and press the  button repeatedly on the remote control until the correct input symbol is displayed on the screen.
Good picture, no sound.	<ul style="list-style-type: none"> • Press the  + button on the remote control. • Check that "TV Speakers" is "On" on the "Detail Set Up" menu. • Check that headphones are not connected.
No colour on colour programmes.	<ul style="list-style-type: none"> • Using the menu system, select the "Picture Adjustment" menu and select "Reset" to return to factory settings.
Distorted picture when changing programmes or selecting teletext.	<ul style="list-style-type: none"> • Turn off any equipment connected to the Scart connector on the rear of the TV.
Wrong characters appear when viewing teletext.	<ul style="list-style-type: none"> • Using the menu system, enter to the "Language/Country" menu and select the country in which you operate the TV set. For Cyrillic languages, we recommend to select Russia country in the case that your own country does not appear in the list.
Picture slanted	<ul style="list-style-type: none"> • Using the menu system, select the "Picture Rotation" option in the "Detail Set Up" menu to correct the picture slant.
Noisy picture when viewing a TV channel.	<ul style="list-style-type: none"> • Using the menu system, select the "Manual Programme Preset" menu and adjust Fine Tuning (AFT) to obtain better picture reception. • Using the menu system, select the "Noise Reduction" option in the "Detail Set Up" menu and select "Auto" to reduce the noise in the picture.
No unscrambling or unstable picture whilst viewing a scrambling channel with a decoder connected through the Scart connector  3 /  3.	<ul style="list-style-type: none"> • Using the menu system, select the "Set Up" menu. Then enter to "Detail Set Up" option and set "AV3 Output" to "TV". • Check that the Decoder is not connected on the scart  2 /  2.
Remote control does not function.	<ul style="list-style-type: none"> • Check that the Media Selector on the remote control is set according to the device you are using (VCR, TV or DVD). • If the remote control does not operate the VCR or DVD even when the Media Selector has been set correctly. Enter the necessary code set as explained on "Remote Control Configuration for VCR/DVD" chapter of this instruction manual. • Replace the batteries.
The standby indicator  on the TV flashes.	<ul style="list-style-type: none"> • Contact your nearest Sony service centre.

 If you continue to experience problems, have your TV serviced by qualified personnel. Never open the casing yourself.

Design and specifications are subject to change without notice.

Ecological Paper - Totally Chlorine Free 

SECTION 2 DISASSEMBLY

2-1. Rear Cover Removal

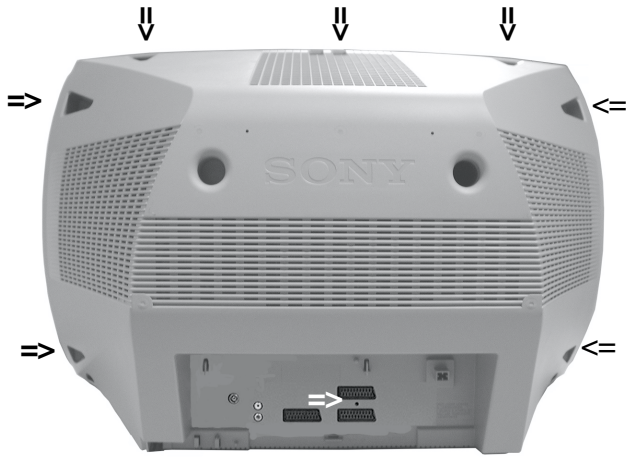

Remove the rear cover fixing screws indicated. Take care when removing the rear cover not to damage the speaker cables [Disconnect the speaker connector] as speakers are fitted inside the rear cover.

2-2. Speaker Connector Disconnection

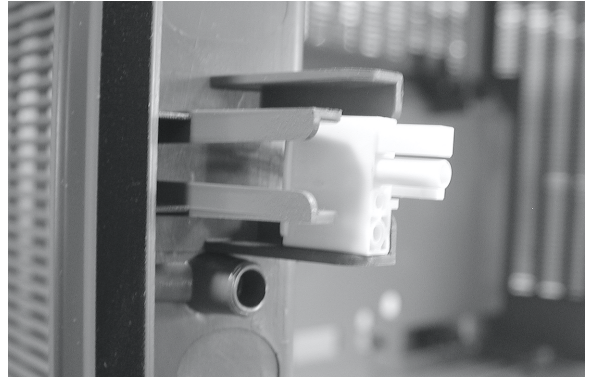

Before completely removing the rear cover disconnect the speaker connector which is located on the inside.

2-3. Chassis Removal and Refitting

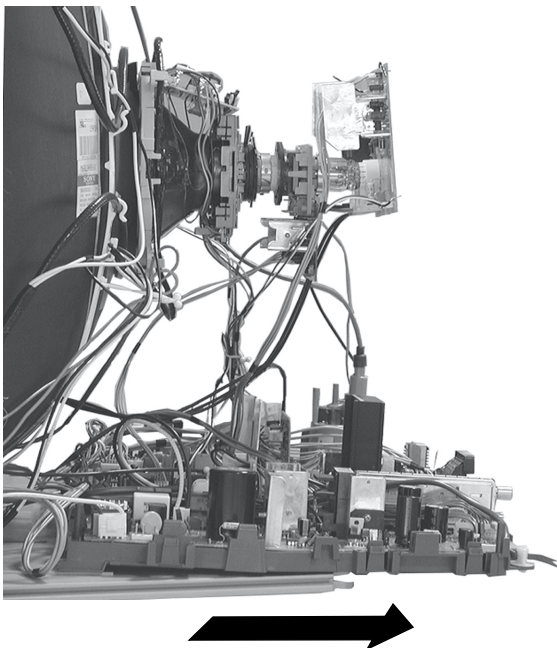

To remove lift the main bracket rear slightly and slide the chassis away from the beznet. Ensure that the interconnecting leads are released from their purse locks to prevent damage being caused.

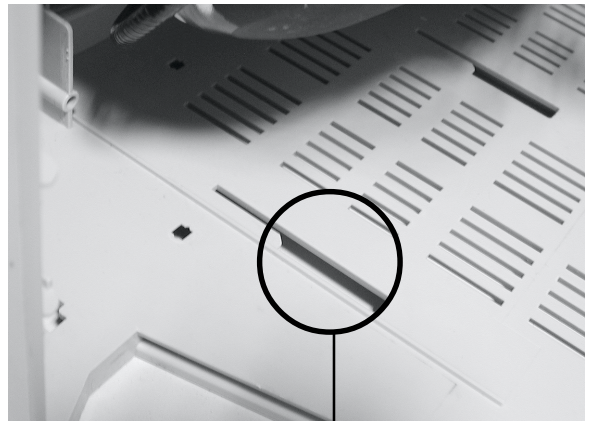

When refitting the chassis ensure that the main bracket is located in the beznet guide slots before sliding the chassis forwards. Refit the interconnecting leads in their respective purse locks.

2-4. Service Position

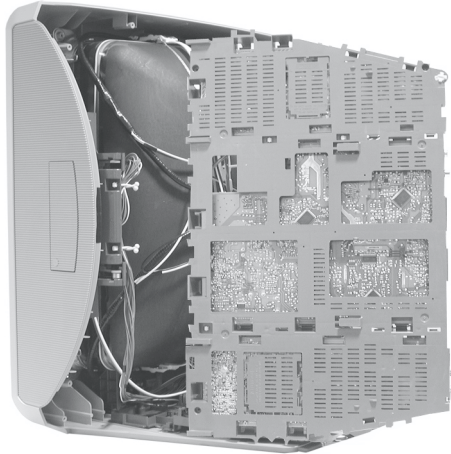

Position the chassis as indicated to access the solder side. To gain access to the underside of the boards follow the instructions on page 17. [Removal and Replacement of the main bracket bottom plates].

2-5. D and G Board Removal

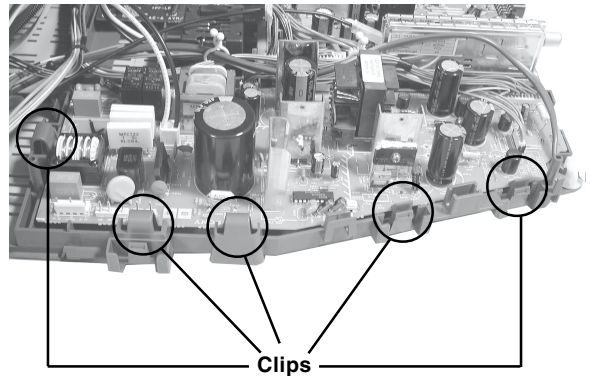

To remove the G Board release the clips circled and ease the board gently away from the support bracket. Removal of the D Board follows the same procedure.

2-6. Side Control Module Removal

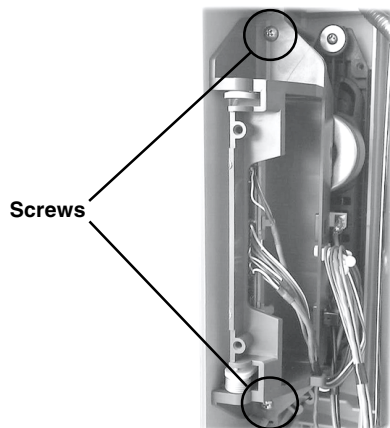

Remove the two screws fixing the user control module to the side of the set. The control module can then be removed by sliding it towards the rear of the set allowing access to the H2 Board.

2-7. H2 Board Removal

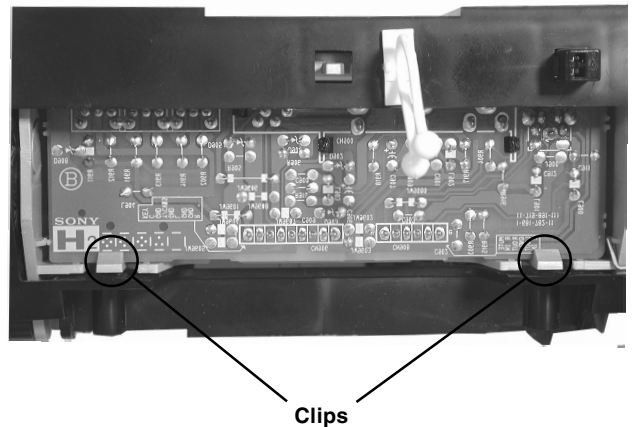

To remove the H2 Board release the two clips circled and ease the board gently away from the support bracket.

2-8. M Board Removal

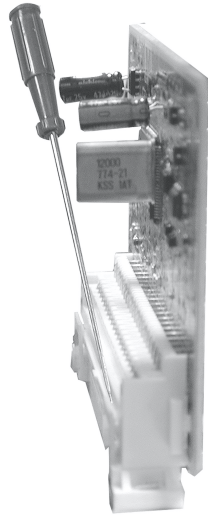

To remove the M Board gently release the two clips with a screwdriver and remove the board from its socket vertically.

2-9. Service Connector for M Board

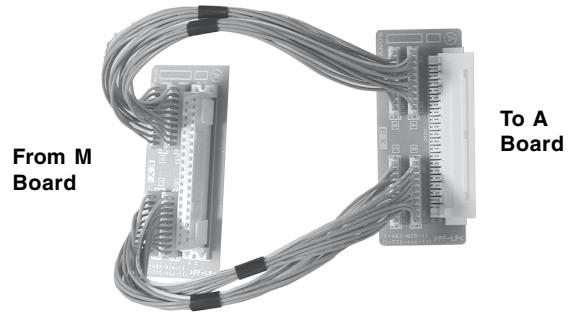

Extender Board Assembly A-1642-293-A

If the M Board needs to be removed for testing when the chassis is placed in its service position, it would be necessary to use an extender board and extension cable as indicated above.

The Extender board and extension cable are available as a service part by ordering the part number as indicated.

2-10. Wire Dressing

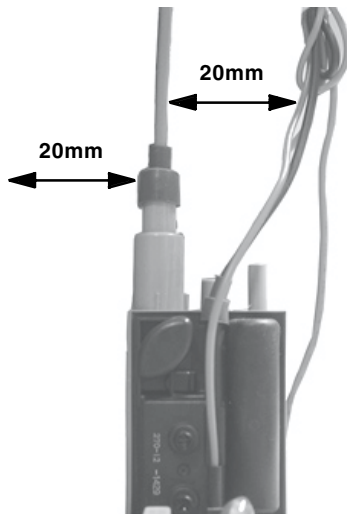

Ensure that wires do not touch heatsinks and high temperature hotspots. All wires must be kept at a minimum distance of 20mm away from the EHT lead

2-11. Picture Tube Removal

WARNING: BEFORE REMOVING THE ANODE CAP

High voltage remains in the CRT even after the power is disconnected. To avoid electric shock, discharge CRT **before** attempting to remove the anode cap. Short between anode and CRT coated earth ground strap.

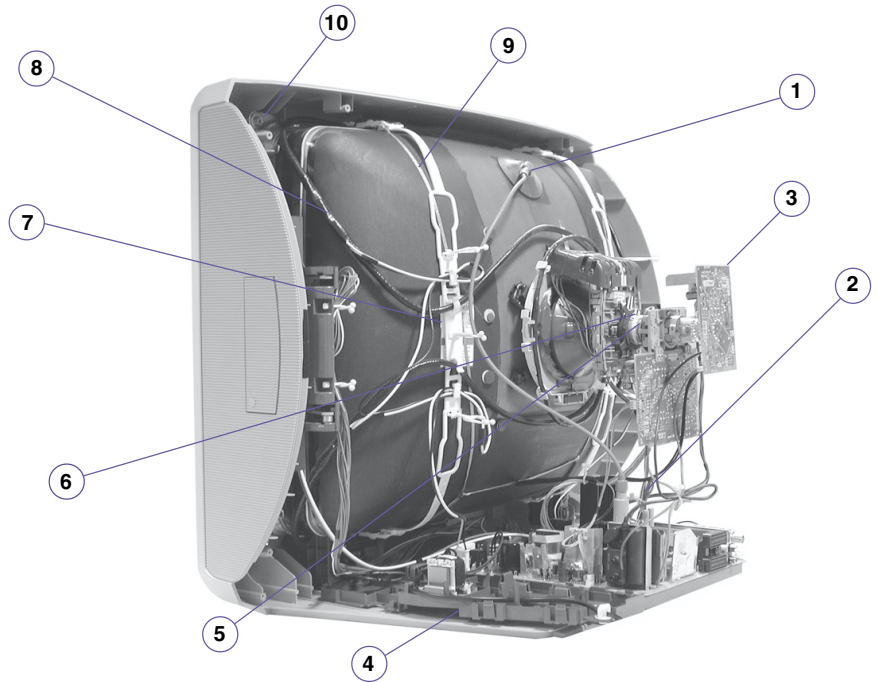
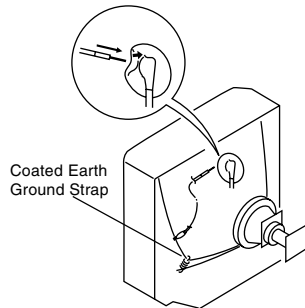

1. Discharge the anode of the CRT and remove the anode cap.
2. Unplug all interconnecting leads from the Deflection yoke, neck assy, degaussing coils and CRT grounding strap.
3. Remove the C Board from the CRT.
4. Remove the chassis assembly.
5. Loosen the Neck assembly fixing screw and remove.
6. Loosen the Deflection yoke fixing screw and remove.
7. Place the set with the CRT face down on a cushion and remove the Degaussing Coil holders.
8. Remove the Degaussing Coils.
9. Remove the CRT grounding strap and spring tensioners.
10. Unscrew the four CRT fixing screws [located on each CRT corner] and remove the CRT.
[Take care not to handle the CRT by the neck.]

Removal of the Anode-Cap

* REMOVING PROCEDURES.

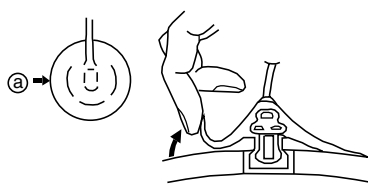

- ① Turn up one side of the rubber cap in the direction indicated by the arrow (a)

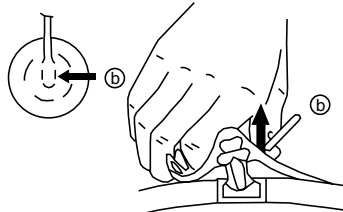

- ② Using a thumb pull up the rubber cap firmly in the direction indicated by the arrow (b)

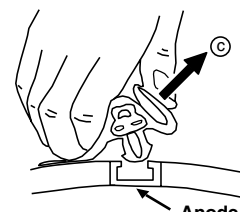

- ③ When one side of the rubber cap is separated from the anode button, the anode-cap can be removed by turning up the rubber cap and pulling it up in the direction of the arrow (c)

How to handle the Anode-Cap

1. To prevent damaging the surface of the anode-cap do not use sharp materials.
2. Do not apply too great a pressure on the rubber, as this may cause damage to the anode connector.
3. A metal fitting called a shatter hook terminal is fitted inside the rubber cap.
4. Do not turn the rubber foot over excessively, this may cause damage if the shatter hook sticks out.

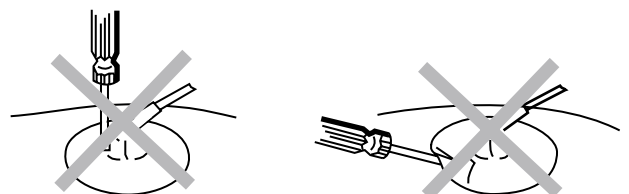

REMOVAL AND REPLACEMENT OF THE MAIN-BRACKET BOTTOM PLATES.

(1) REMOVING THE PLATES

In the event of servicing being required to the solder side of the D Board printed wiring board, the bottom plates fitted to the main chassis bracket require to be removed.

This is performed by cutting the gates with a sharp wire cutter at the locations indicated by the arrows.

Note : There are 3 plates fitted to the main bracket and secured by 3 gates.
Only remove the necessary plate to gain access to the printed wiring board.

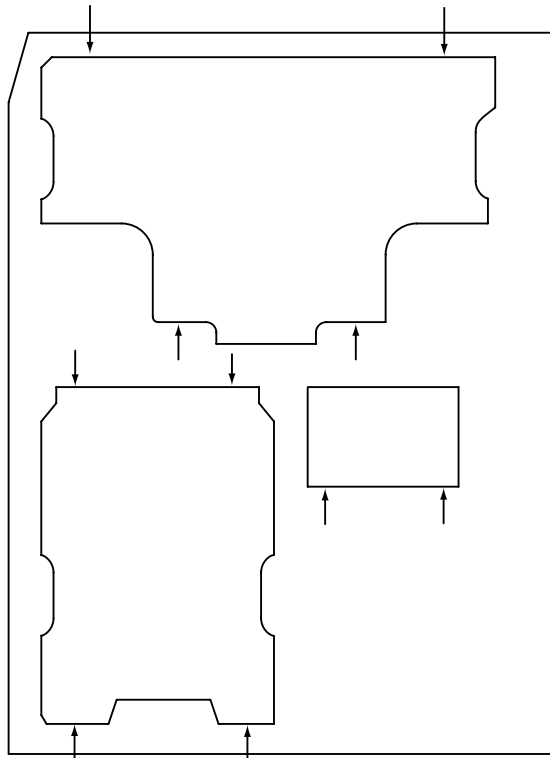

For safety reasons, on no account should the plates be removed and not refitted after servicing.

(2) REFITTING THE PLATES

Because the plates differ in size it is important that the correct plates are refitted in their original location.

Please note that the plates need to be rotated 180 degrees from their cut position to allow the tabs to be fitted into their catch positions.

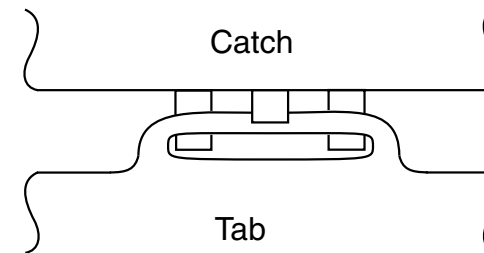

SECTION 3 SET-UP ADJUSTMENTS

- When complete readjustment is necessary or a new picture tube is installed, carry out the following adjustments.
- Unless there are specific instructions to the contrary, carry out these adjustments with the rated power supply.
- Unless there are specific instructions to the contrary, set the controls and switches to the following settings :

Contrast normal

Brightness normal

Carry out the adjustments in the following order :

- 3-1. Beam Landing.
- 3-2. Convergence.
- 3-3. Focus.
- 3-4. White Balance.

Note : Test equipment required.

1. Color bar/pattern generator.
2. Degausser.
3. Oscilloscope.
4. Digital multimeter.

3-1. Beam Landing

Preparation :

1. In order to reduce the influence of geomagnetism on the set's picture tube, face it in an easterly or westerly direction.
2. Switch on the TV set's power and degauss with a degausser.

(1) Adjustment of Correction Magnet for Y-Splitting Axis.

1. Input a crosshatch signal from the pattern generator.
2. Set the Picture control to minimum and confirm that the Brightness control is set to normal.
3. Position the neck assembly as indicated in Fig.3-2.
4. Loosen the deflection yoke fixing screw.
5. Move the deflection yoke as far forward as is possible.
6. Adjust the upper and lower pin symmetrically by opening or closing the Y-splitting axis correction magnets located on the neck assembly. [See Fig 3-3]
7. Return the deflection yoke to its original position and re-tighten its fixing screw.

Fig.3-1

Y-splitting axis correction magnet

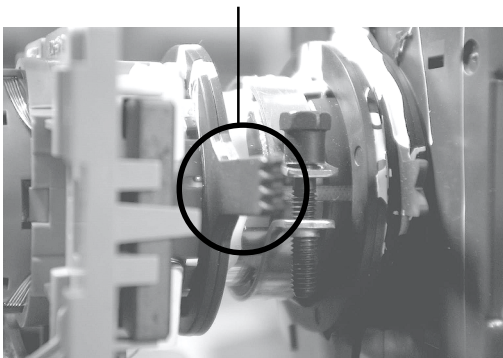

Caution :

High voltages are present on the Deflection yoke terminals - take care when handling the Deflection yoke whilst carrying out adjustments.

(2) Landing

Note : Before carrying out the following adjustments adjust the magnets as indicated below [See Fig.3-4].

1. Input a crosshatch signal from the signal generator.
2. Rough-adjust the focus and horizontal convergence.
3. Switch from the crosshatch pattern to an all-red pattern.
4. Move the deflection yoke backwards and adjust with the purity magnet so that the red is at the centre and it aligns symmetrically [See Fig.3-5].
5. Move the deflection yoke forward to the point where the entire screen just becomes red [Mark its position].
6. Move the deflection yoke further forward until the screen just changes colour at the edges. [Mark its position]
7. Position the deflection yoke between the two marks indicated above.
8. Input a crosshatch pattern from the pattern generator and rotate the deflection yoke so that the horizontal lines are parallel with the top and bottom of the screen.
9. When the position of the deflection yoke has been determined, fasten it with its fixing screw.
10. Switch the pattern generator to green then blue and confirm the purity.
11. If the beam does not land correctly in all the corners of the screen, use disk magnets to correct it. [Confirm the corner landing for green and blue]

Fig.3-2

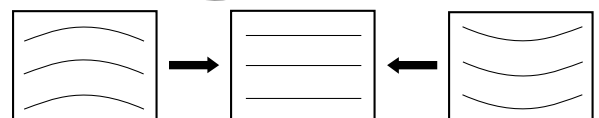
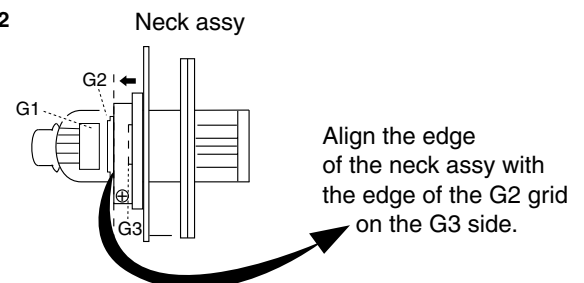
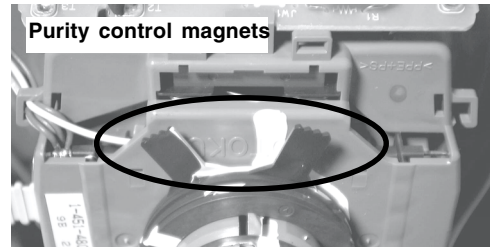
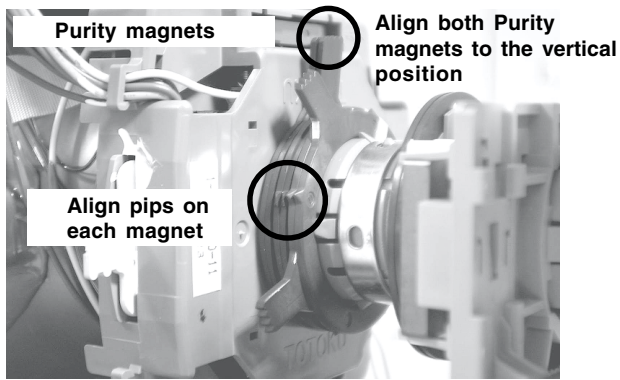

Fig.3-3

Fig.3-4



3-2. Convergence

(1) Screen centre convergence [Static convergence]

1. Input a dot pattern signal from the pattern generator.
2. Normalize the picture setting.
3. [Moving vertically], adjust the V.STAT magnet so that the vertical red, green and blue dots coincide at the centre of the screen.

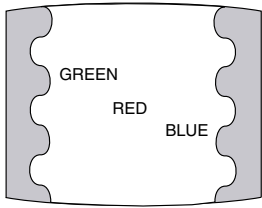
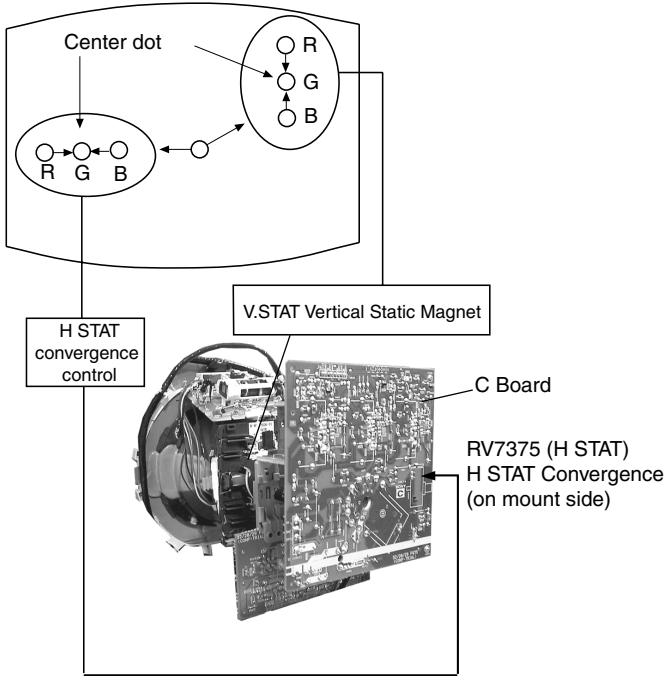
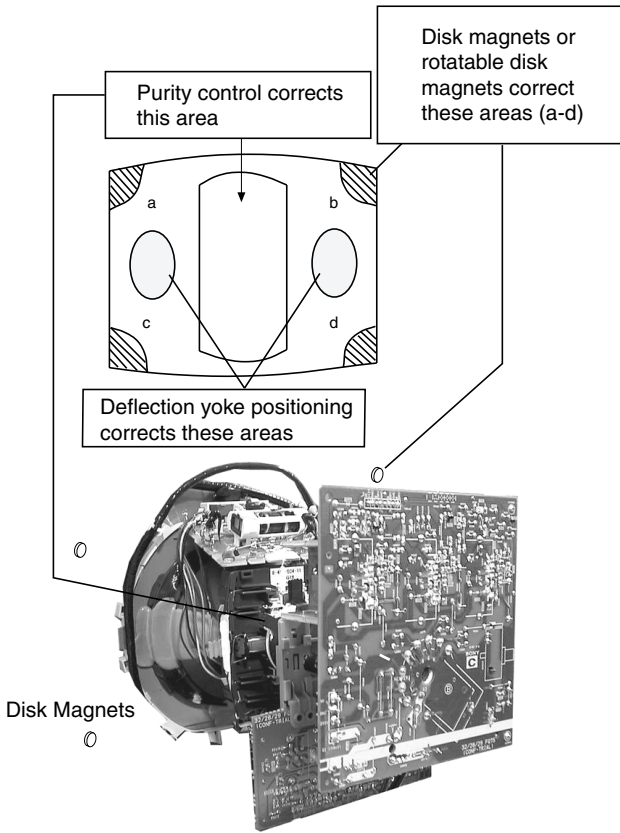
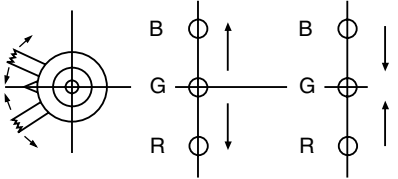

Fig.3-5



By opening or closing the V.STAT magnet, the red green and blue dots move in the direction indicated below.



Note: Do not adjust the H.STAT by rotating the V.STAT magnets as this can affect the focus setting.

4. Correction for HMC [Horizontal mis-convergence] and VMC [Vertical mis-convergence] by using the BMC [Hexapole] magnet.

a). HMC correction by BMC [Hexapole] magnet and movement of the electron beam.

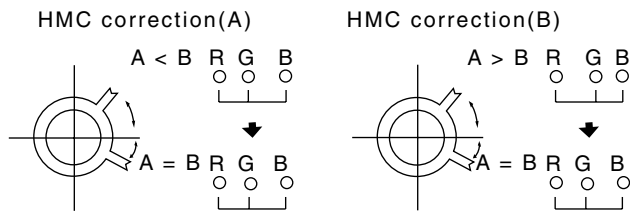

HTIL correction can be performed by adding a THL correction assembly to the Deflection yoke.

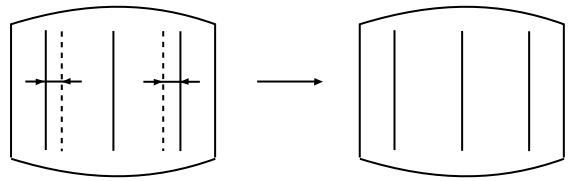

YCH Adjustment

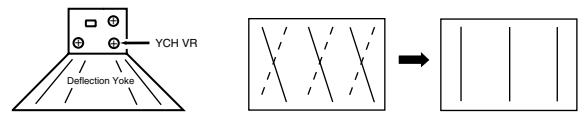

b). VMC correction by BMC [Hexapole] magnet and movement of the electron beam.

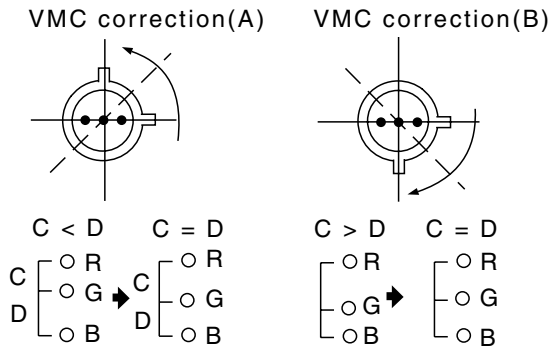

TLV Adjustment

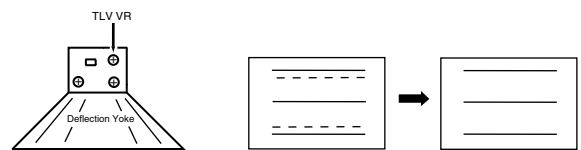

HAMP Adjustment

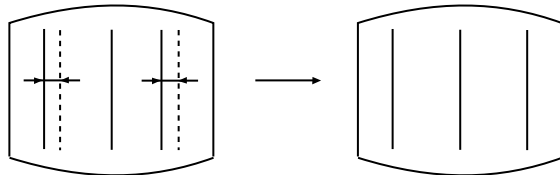

Adjust the HAMP using HAMPL and HAMPR registers in the Dynamic Convergence section of the service menu.

H-TRAP Adjustment

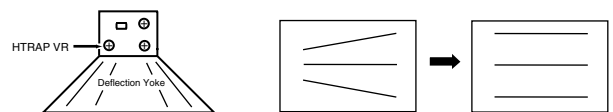

HTIL Adjustment

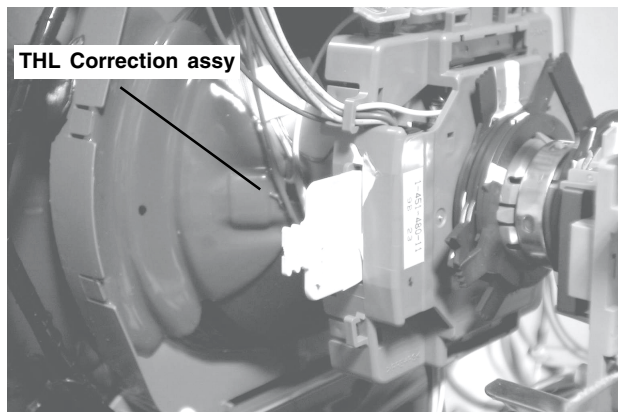

The H-TRAP should not be adjusted unless absolutely necessary as it affects the TLV settings.

Layout of each control

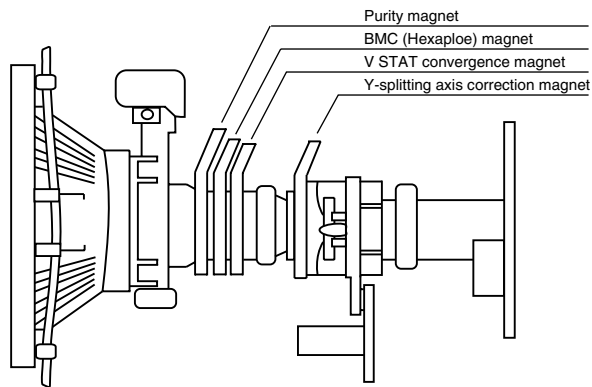

Note : If you are unable to adjust the corner convergence properly, this can be corrected with the use of permalloy magnets.

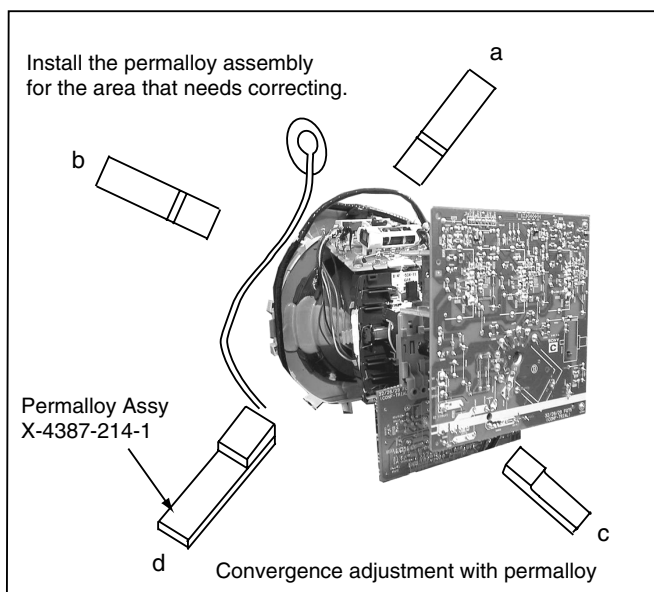
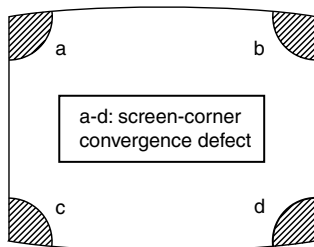

3-3. Focus Adjustment

1. Receive a television broadcast signal.
2. Normalize the picture setting.
3. Adjust the focus control located on the flyback transformer to obtain the best focus at the centre of the screen. Bring only the centre area of the screen into focus, the magenta-tinging appears on the screen. In this case, adjust the focus to optimize the screen uniformly.

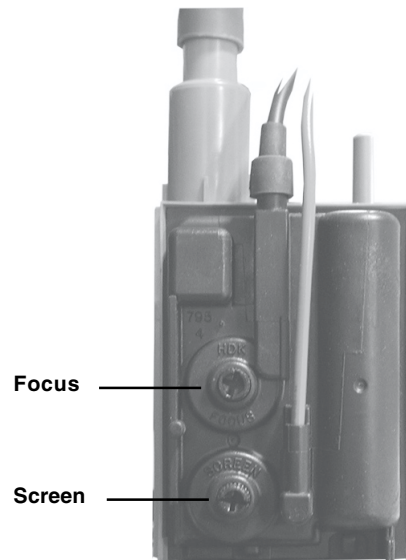

3-4. Screen (G2), White Balance

[Adjustment in the service mode using the remote commander]

G2 adjustment

1. Input a dot signal from the pattern generator.
2. Set the Picture, Brightness and Colour to minimum.
3. Apply 165V DC from an external power supply to the R, G and B cathodes of the CRT.
4. Whilst watching the picture, adjust the G2 control [SCREEN] located on the flyback transformer to the point just before the flyback return lines disappear.

White balance adjustment for TV mode

1. Input an all-white signal from the pattern generator.
2. Program the Remote Commander for operation in Service Mode. [See Page 22].
3. Enter into the 'Service Mode' by pressing 'VIDEO' button twice and 'MENU' on the Service Commander.
4. Select 'Service' from the on screen menu display and press 'Right Arrow'.
5. The 'Service' menu will appear on the screen.[See Page 23]
6. Set the 'Contrast' to MAX.
7. Set the 'R-Drive' to 50.
8. Adjust the 'G-Drive' and the 'B-Drive' so that the white balance becomes optimum.
9. Press the 'OK' button to write the data for each item.
10. Set the 'Contrast' to MIN.
11. Set the 'R-Cutoff' to 29.
12. Adjust the 'G-Cutoff', and the 'B-Cutoff' with the left and right buttons on the remote commander so that the white balance becomes optimum.
13. Press the 'OK' button to write the data for each item.

SECTION 4 CIRCUIT ADJUSTMENTS

4-1. Electrical Adjustments

Service adjustments to this model can be performed using the supplied remote Commander RM-932.

Programming the Remote Commander for Operation in Service Mode

1. Press the VCR/TV/DVD button until the TV LED lights.
2. Press and hold the yellow button for approx. 5 seconds until the TV LED flashes quickly.
3. Press 99999. All three LED's should light. The remote commander is now set to Service Mode.
4. To return the remote commander to normal operation mode repeat steps 1. and 2. then press 00000. All three LED's should light. The remote commander is now set to normal mode.



Setting the TV into Service Mode

1. Program the remote commander for operation in Service Mode as described above.
2. Turn on the TV main power switch.
3. Press the video standby button  on the remote commander twice. 'TT ___' will appear in the upper right corner of the screen. Other status information will also be displayed.
4. Press 'MENU' on the remote commander to obtain the following menu on the screen.

Geometry
 Service
 Scanrate
 DAC
 Dyn. Conv.
PIP
 Sound
 IF adjust
 Error Menu

AE6B v0.14 (Jun 2001)
 Factory data FFh FFh
 MSP Device : MSP3411G

5. Move to the corresponding adjustment item using the up or down arrow buttons on the Remote Commander.
6. Press the right arrow button to enter into the required menu item.
7. Press the 'Menu' button on the Remote Commander to quit the Service Mode when all adjustments have been completed.

Note :

- After carrying out the service adjustments, to prevent the customer accessing the 'Service Menu' switch the TV set OFF and then ON.

GEOMETRY

ABL TH	(0, 3)	0
ABL MODE	(0, 3)	0
P ABL	(0, 15)	15
V SIZE	(0, 63)	35
V POSITION	(0, 63)	33
V COMP	(0, 3)	1
V LIN	(0, 15)	7
S CORRECTION	(0, 15)	7
H SIZE	(0, 63)	44
PIN AMP	(0, 63)	32
UP CORNERPIN	(0, 63)	29
M PIN	(0, 3)	2
LO CORNERPIN	(0, 63)	29
TRAPEZIUM	(0, 15)	2
H POSITION	(0, 63)	40
AFC BOW	(0, 15)	8
AFC ANGLE	(0, 15)	9
LEFT BLK	(0, 63)	34
RIGHT BLK	(0, 63)	17
V ASPECT	(0, 63)	47
AKBTIM1	(0, 3)	2
AKBTIM2	(0, 1)	0
IKR		1
HNG		0
VNG		0

DYN. CONV.

RANGE	(0, 63)	63
YupL	(0, 1)	0
VAL	(0, 63)	30
YlowL	(0, 1)	0
VAL	(0, 63)	31
MBOWupL	(0, 1)	0
VAL	(0, 63)	31
MBOWlowL	(0, 1)	0
VAL	(0, 63)	32
HAMPL	(0, 1)	0
VAL	(0, 63)	37
YupR	(0, 1)	0
VAL	(0, 63)	30
YlowR	(0, 1)	0
VAL	(0, 63)	30
MBOWupR	(0, 1)	0
VAL	(0, 63)	32
MBOWlowR	(0, 1)	0
VAL	(0, 63)	32
HAMPR	(0, 1)	0
VAL	(0, 63)	36
UP Y	(0, 1)	0
VAL	(0, 63)	31
LOW Y	(0, 1)	0
VAL	(0, 63)	33
H STAT	(0, 1)	0
VAL	(0, 63)	33
UP CORR	(0, 1)	0
VAL	(0, 63)	34
LOW CORR	(0, 1)	0
VAL	(0, 63)	19

IF ADJUST		
Automute		1
Audio Gain		0
L Gating		0

SERVICE		
SUB COL	(0, 63)	Adj 31
SUB HUE	(0, 63)	30
SUB SHARP	(0, 63)	13
SUB BRIGHT	(0, 63)	12
SUB CONT	(0, 15)	50
R-DRIVE	(0, 63)	Adj
G-DRIVE	(0, 63)	Adj
B-DRIVE	(0, 63)	Adj
R CUTOFF	(0, 63)	28
G CUTOFF	(0, 63)	24
B CUTOFF	(0, 63)	46
Br TXT	(0, 15)	7
Br OSD	(0, 15)	10

DAC		
CONFIG		00000000
MPIN CONT	(0, 255)	96
HLIN	(0, 255)	83
HTRAP	(0, 255)	127
ROT. COIL	(0, 255)	130
PHOCUS PH	(0, 255)	90

SOUND		
M-N	(0, 511)	200
M-D	(-128, -1)	-20
M-S	(+0, +127)	+20
S-M	(+0, +127)	+10
D-M	(-128, -1)	-10
N-M	(0, 1023)	496
BBE	(+0, +68)	+28
B1	(-96, +96)	+0
B2	(-96, +96)	+0
B3	(-96, +96)	+0
B4	(-96, +96)	+0
B5	(-96, +96)	+0
SW L	(-128, +0)	+0
SW F	(+5, +40)	+30
NICAM C AD		10001
NICAM Error	(0, 2047)	0
Stereo	(-128, +127)	+0
Status		000000110

ERROR MENU			
E02	OCP	(0, 255)	0
E03	OVP	(0, 255)	0
E04	VSUNC	(0, 255)	0
E05	IKR	(0, 255)	0
E06	IIC	(0, 255)	0
E07	NVM	(0, 255)	0
E08	HPROT	(0, 255)	0
E09	TUNER	(0, 255)	0
E10	SOUNDP	(0, 255)	0
E11	-	(0, 255)	0
E12	SCANRATE	(0, 255)	0
E13	DAC	(0, 255)	0
E14	BACKEND	(0, 255)	0
E15	DYN CON	(0, 255)	0
E16	PIP	(0, 255)	0
WORKING TIME			
HOURS			14
MINUTES			7

Sub Brightness Adjustment

1. Input a Monoscope pattern.
2. Program the Remote Commander for operation in Service Mode. [See Page 22].
3. Press 'VIDEO' 'VIDEO' 13 on the Remote Commander.
4. Adjust the 'Sub-Brightness' data so that there is barely a difference between the 0 IRE and 10 IRE signal levels.

Sub Contrast Adjustment

1. Input a video signal that contains a small 100% white area on a black background.
2. Connect an digital voltmeter to Pin 10 of J7378 [C Board].
3. Program the Remote Commander for operation in Service Mode. [See Page 22].
4. Adjust the Sub-Contrast [Using 'VIDEO' 'VIDEO' '11'] to obtain a voltage of 105 +/- 5V.

Sub Colour Adjustment

1. Receive a PAL colour bar signal.
2. Connect an oscilloscope to Pin 6 of CN7001 [A Board].
3. Program the Remote Commander for operation in Service Mode. [See Page 22].
4. Adjust the 'Sub Colour' [Using 'VIDEO' 'VIDEO' '12'] so that the Cyan, Magenta and Blue colour bars are of equal levels as indicated below.

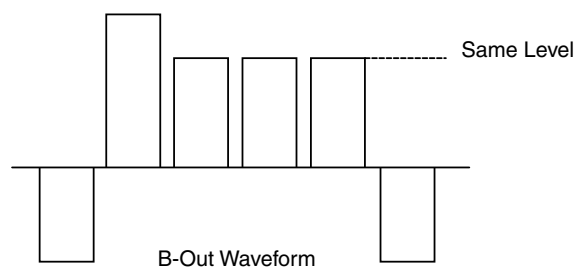

Deflection System Adjustment

1. Program the Remote Commander for operation in Service Mode. [See Page 22] and enter into the 'Geometry' service menu.
2. Select and adjust each item in order to obtain the optimum image.

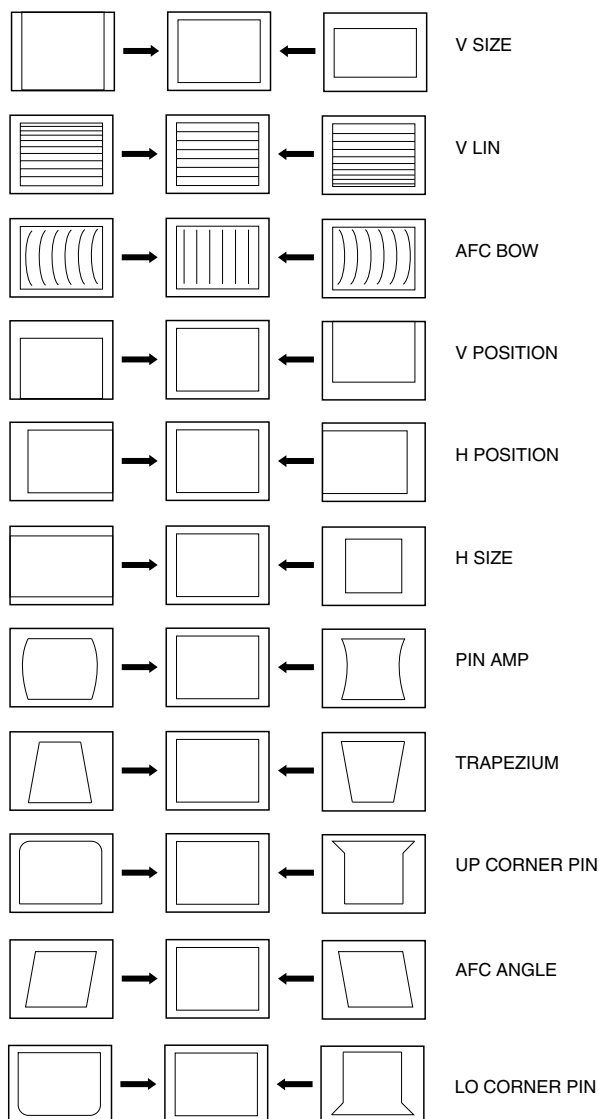

GEOMETRY

ABL TH	(0, 3)	0
ABL MODE	(0, 3)	0
P ABL	(0, 15)	15
V SIZE	(0, 63)	35
V POSITION	(0, 63)	33
V COMP	(0, 3)	1
V LIN	(0, 15)	7
S CORRECTION	(0, 15)	7
H SIZE	(0, 63)	44
PIN AMP	(0, 63)	32
UP CORNERPIN	(0, 63)	29
M PIN	(0, 3)	2
LO CORNERPIN	(0, 63)	29
TRAPEZIUM	(0, 15)	2
H POSITION	(0, 63)	40
AFC BOW	(0, 15)	8
AFC ANGLE	(0, 15)	9
LEFT BLK	(0, 63)	34
RIGHT BLK	(0, 63)	17
V ASPECT	(0, 63)	47
AKBTIM1	(0, 3)	2
AKBTIM2	(0, 1)	0
IKR		1
HNG		0
VNG		0

4-2. TEST MODE 2:

Test Mode 2 is available by programming the Remote Commander for operation in Service Mode [As shown on Page 22] then pressing the 'VIDEO' button twice, OSD 'TT' appears. The functions described below are available by selecting the two numbers. To release the 'Test mode 2', press 00, 10, 20 ... twice or switch the TV set into Stand-by mode. In 'TT Menu' mode, it is possible to remove the Menu from the screen by pressing the Speaker Off button once. Pressing the Speaker OFF button a second time will cause the Menu to reappear. The function is kept even when the menu is not displayed on screen !!.

00	'TT' mode off
01	Picture maximum
02	Picture minimum
03	Set speaker/headphone Volume to 35%
04	Set speaker/headphone Volume to 50%
05	Set speaker/headphone Volume to 65%
06	Set speaker/headphone Volume to 80%
07	Ageing mode
08	Shipping Condition
11	Sub picture adjustment
12	Sub colour adjustment
13	Sub Brightness adjustment
14	Text H Position adjustment
15	Rotation Coil Test
16	Picture level 50%
19	Factory Mode Enable/Disable
21	Destination ADEKR
22	Destination BL
23	Destination ADEKR
24	Destination U
25	Destination ADEKR
26	Destination BL
27	Destination ADEKR
28	Destination ADEKR
31	Auto Shutoff Enable/Disable
36	Velocity Modulation (VM) OFF/ON test
41	Re-initialise NVM
43	Select Dual A sound
44	Select Dual B sound
45	Select Mono sound
46	Select Stereo sound
48	Set NVM as non virgin
49	Set NVM as virgin
53	FM Overmodulation Enable/Disable
55	Tuner selection (SONY/ALPS)
59	Select Model 3 Scarts + PIP or 2 Scarts
68	Enable/Disable X26 countermeasure (N problem)
73	Enable Zweiton D/K2 system (6.5/6.74)
74	Enable Zweiton D/K3 system (6.5/5.74)
78	Balance full right
79	Balance full left
87	Local keys test
99	Display Error and Working Time menu

5-1. BLOCK DIAGRAMS (1)

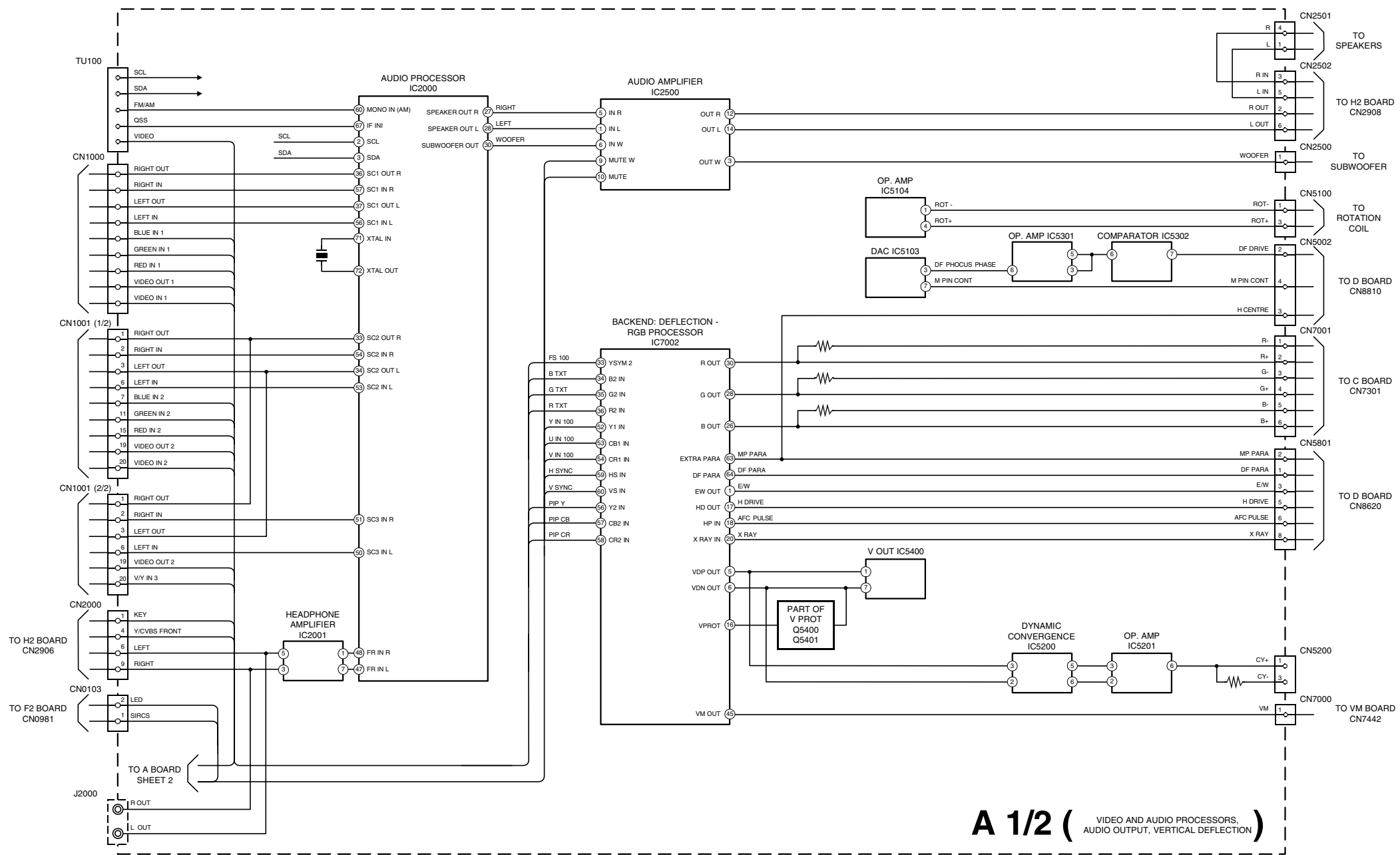
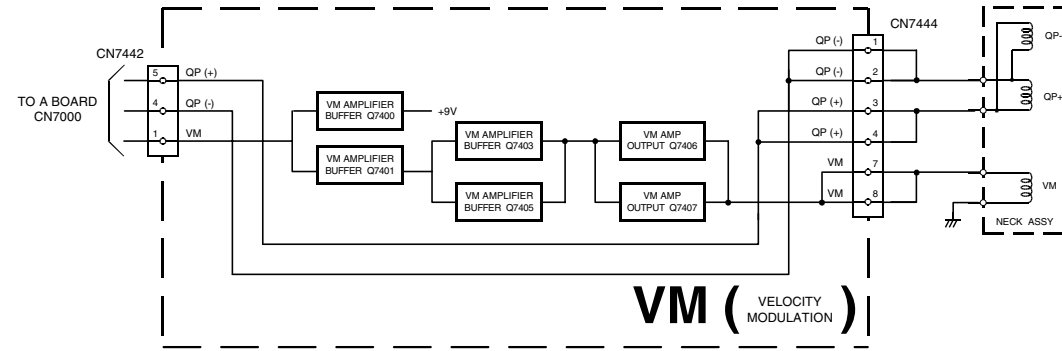

5-1. BLOCK DIAGRAMS (2)

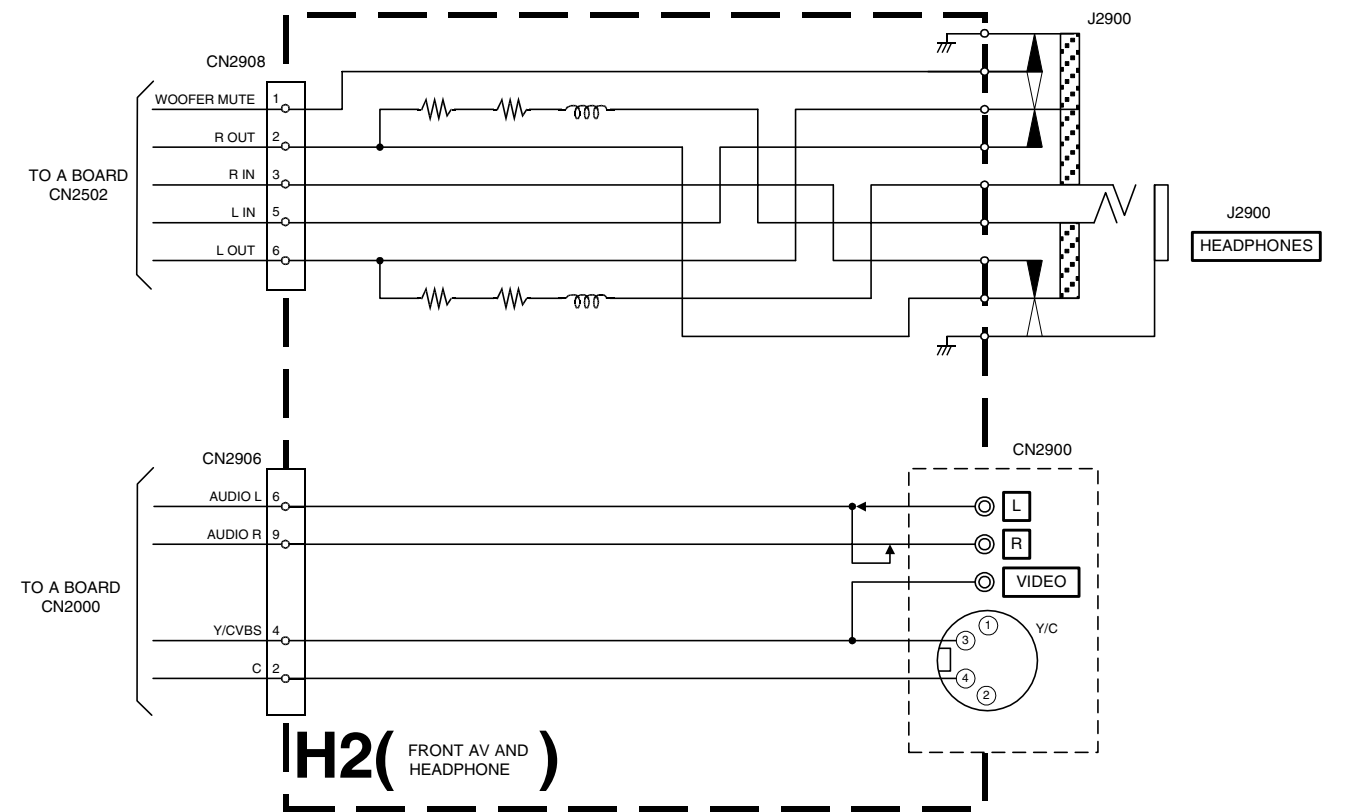
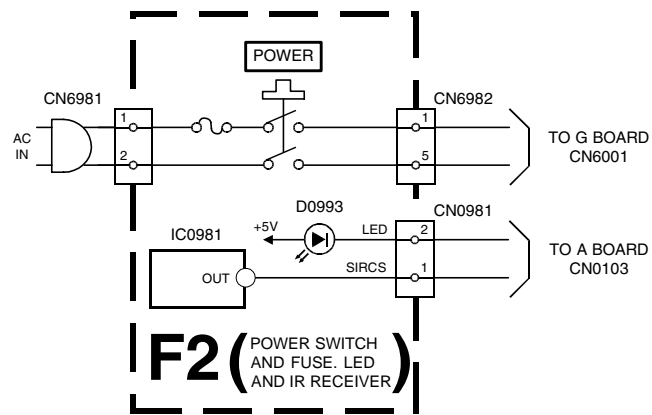
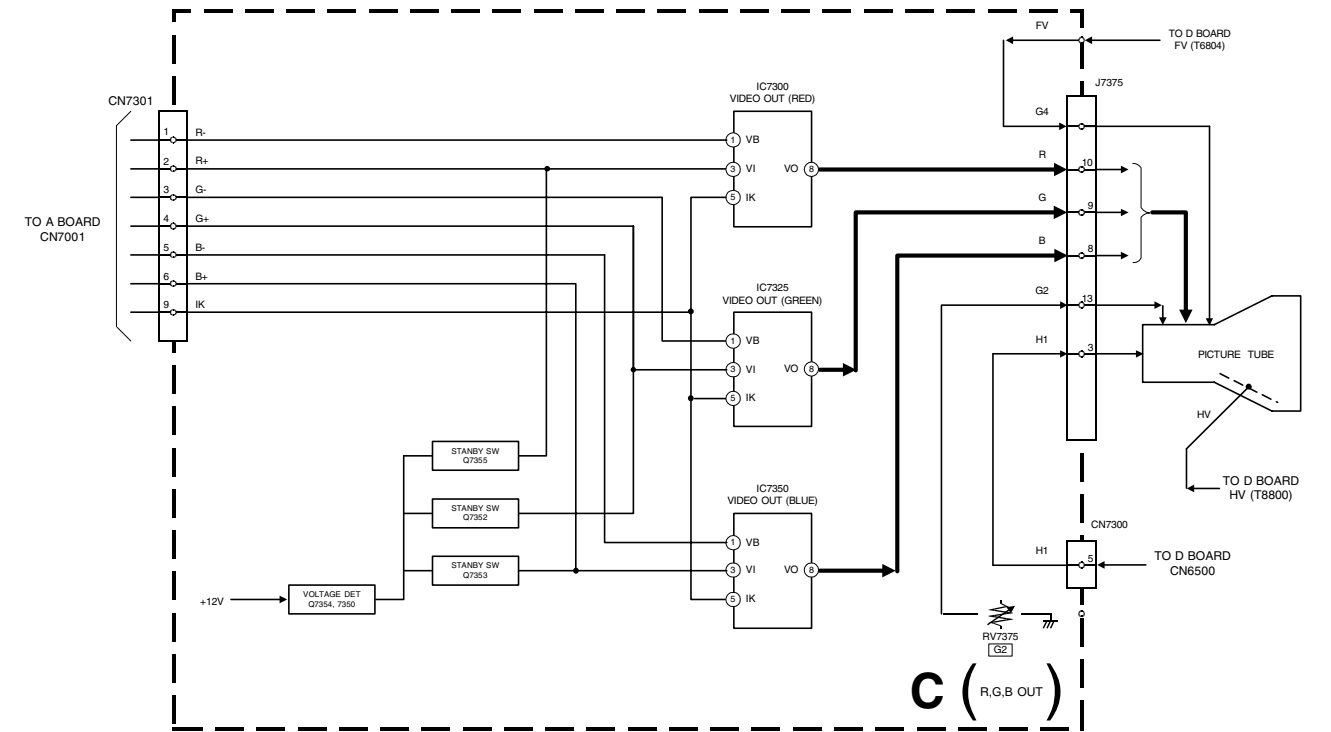
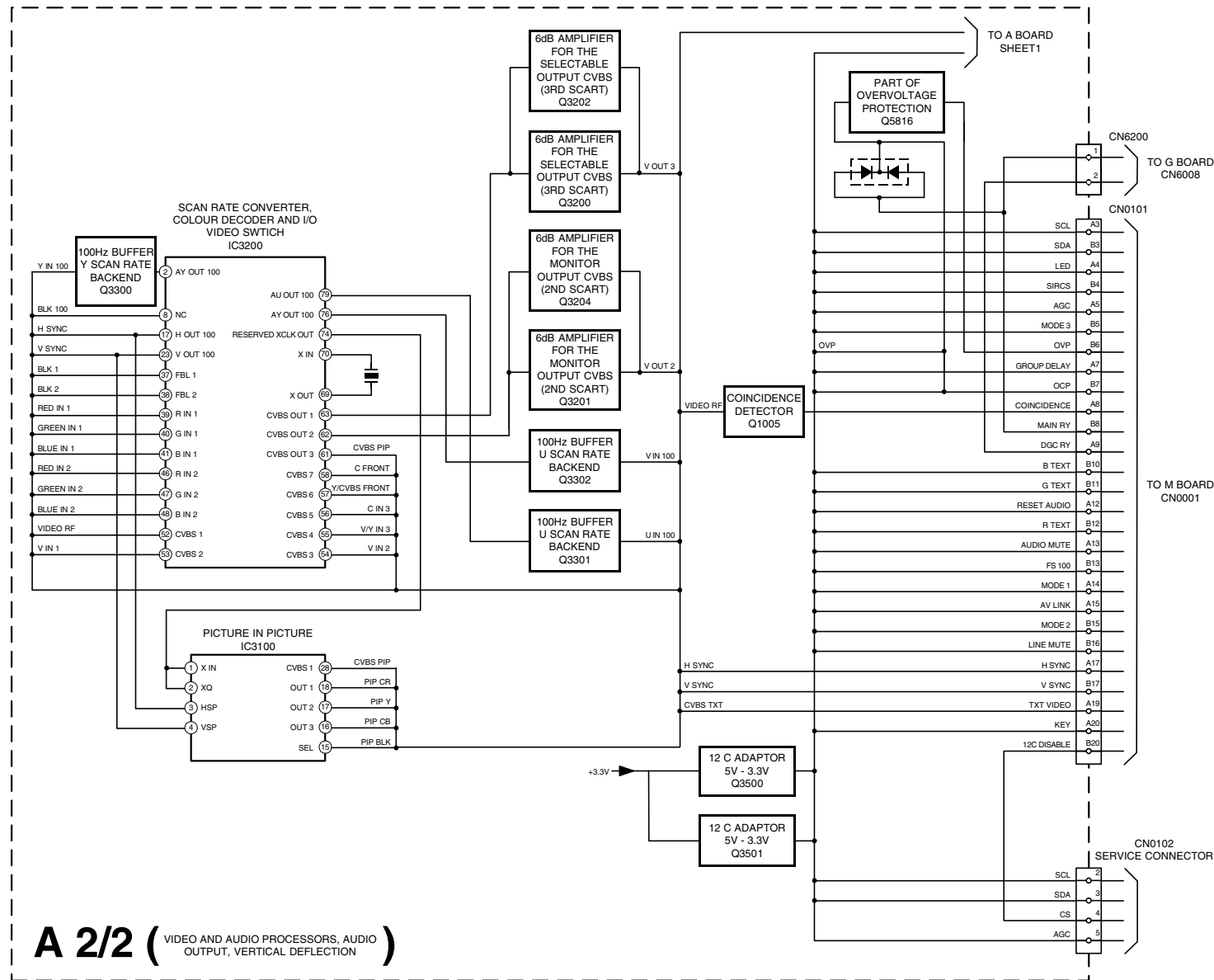

5-1. BLOCK DIAGRAMS (3)

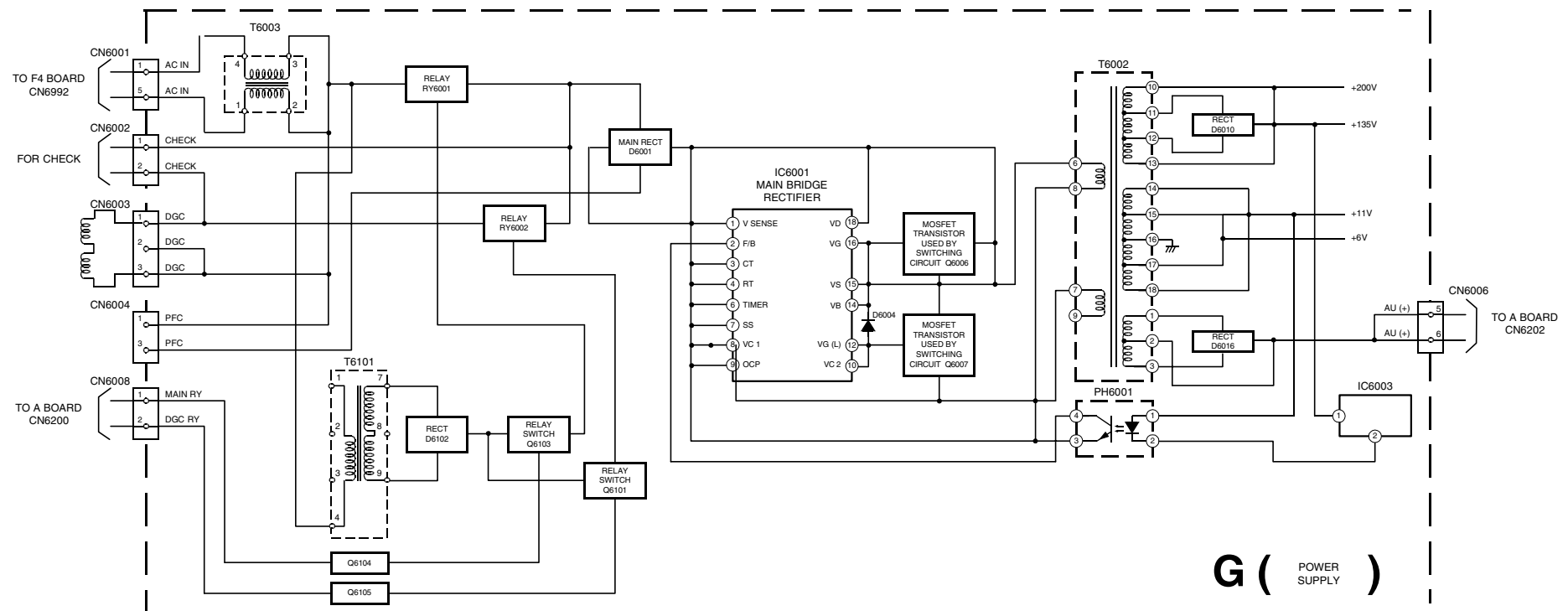
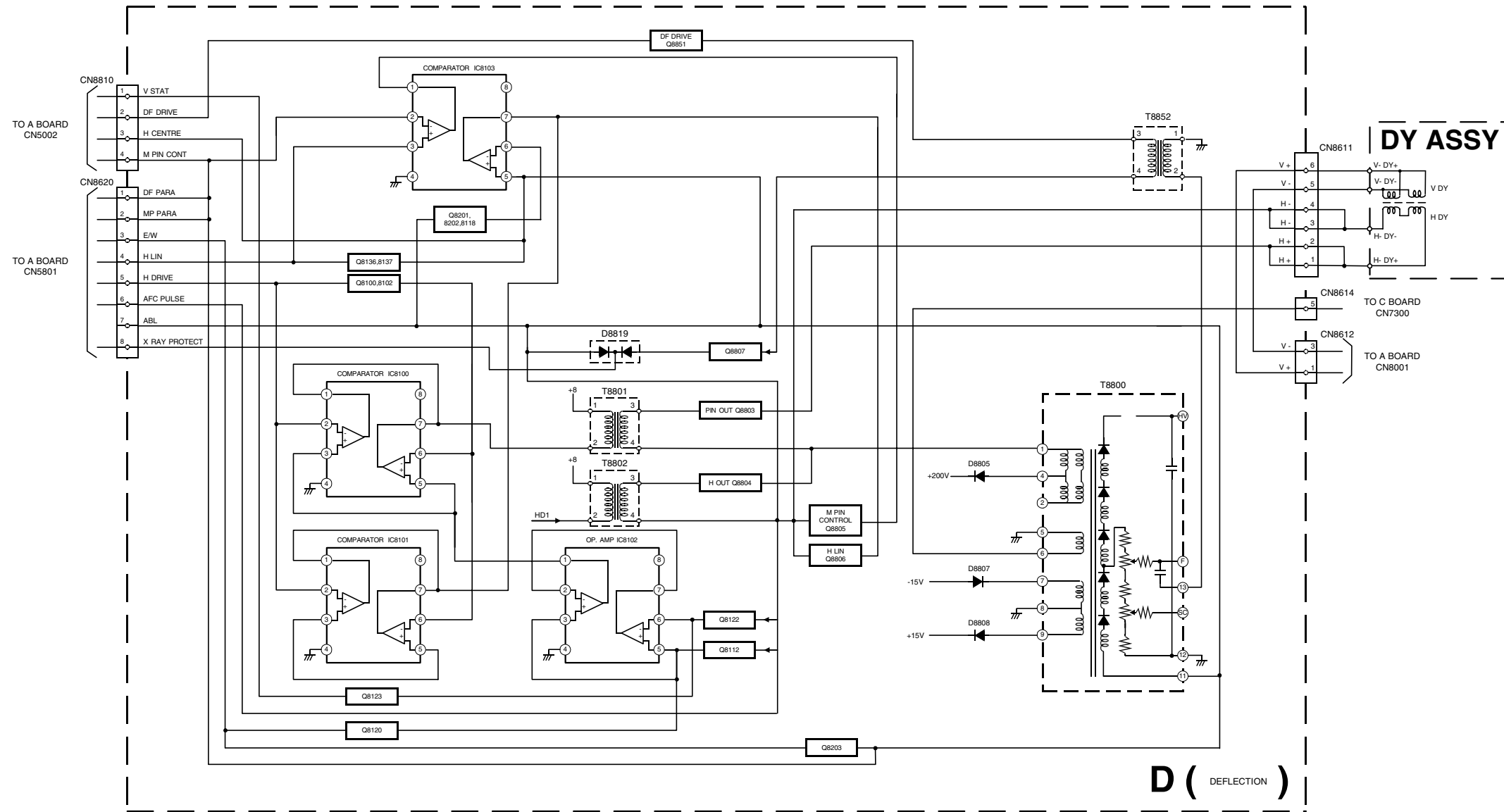

5-1. BLOCK DIAGRAMS (4)

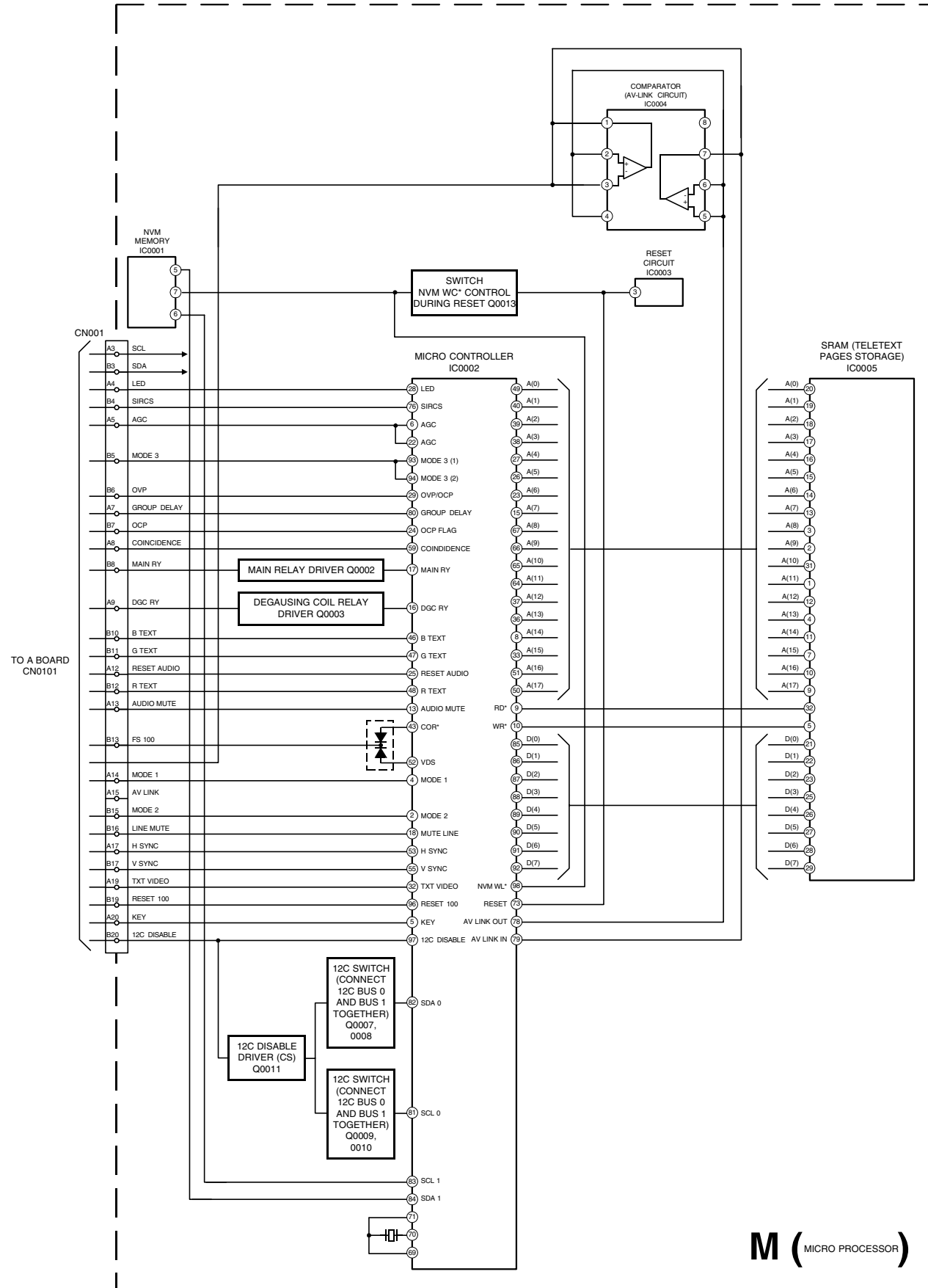

5-2. CIRCUIT BOARD LOCATION

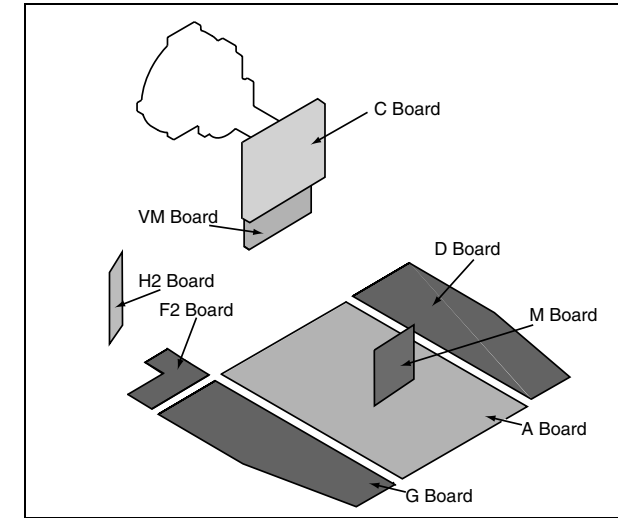

5-3. SCHEMATIC DIAGRAMS AND PRINTED WIRING BOARDS

Note :

- All capacitors are in μF unless otherwise noted.
- pF : μF 50WV or less are not indicated except for electrolytic types.
- Indication of resistance, which does not have one for rating electrical power, is as follows.

Pitch : 5mm
Electrical power rating : 1/4W

- Chip resistors are 1/10W
- All resistors are in ohms.
- $k = 1000$ ohms, $M = 1000,000$ ohms

- : nonflammable resistor.
- : fusible resistor.
- : internal component.
- : panel designation or adjustment for repair.

- All variable and adjustable resistors have characteristic curve B, unless otherwise noted.
- All voltages are in Volts.
- Readings are taken with a 10Mohm digital mutimeter.
- Readings are taken with a color bar input signal.
- Voltage variations may be noted due to normal production tolerences.

- : B + bus.
- : B - bus.
- : RF signal path.
- : earth - ground.
- : earth - chassis.

Reference Information

RESISTOR	RN	: METAL FILM
	RC	: SOLID
	FPRD	: NON FLAMMABLE CARBON
	FUSE	: NON FLAMMABLE FUSIBLE
	RS	: NON FLAMMABLE METAL OXIDE
	RB	: NON FLAMMABLE CEMENT
	RW	: NON FLAMMABLE WIREWOUND
		: ADJUSTMENT RESISTOR
COIL	LF-8L	: MICRO INDUCTOR
CAPACITOR	TA	: TANTALUM
	PS	: STYROL
	PP	: POLYPROPYLENE
	PT	: MYLAR
	MPS	: METALIZED POLYESTER
	MPP	: METALIZED POLYPROPYLENE
	ALB	: BIPOLAR
	ALT	: HIGH TEMPERATURE
	ALR	: HIGH RIPPLE

Note : The components identified by shading and marked Δ are critical for safety. Replace only with the part numbers specified in the parts list.

Note : Les composants identifiés par une trame et par une marque Δ sont d'une importance critique pour la sécurité. Ne les remplacer que par des pièces de numéro spécifié.

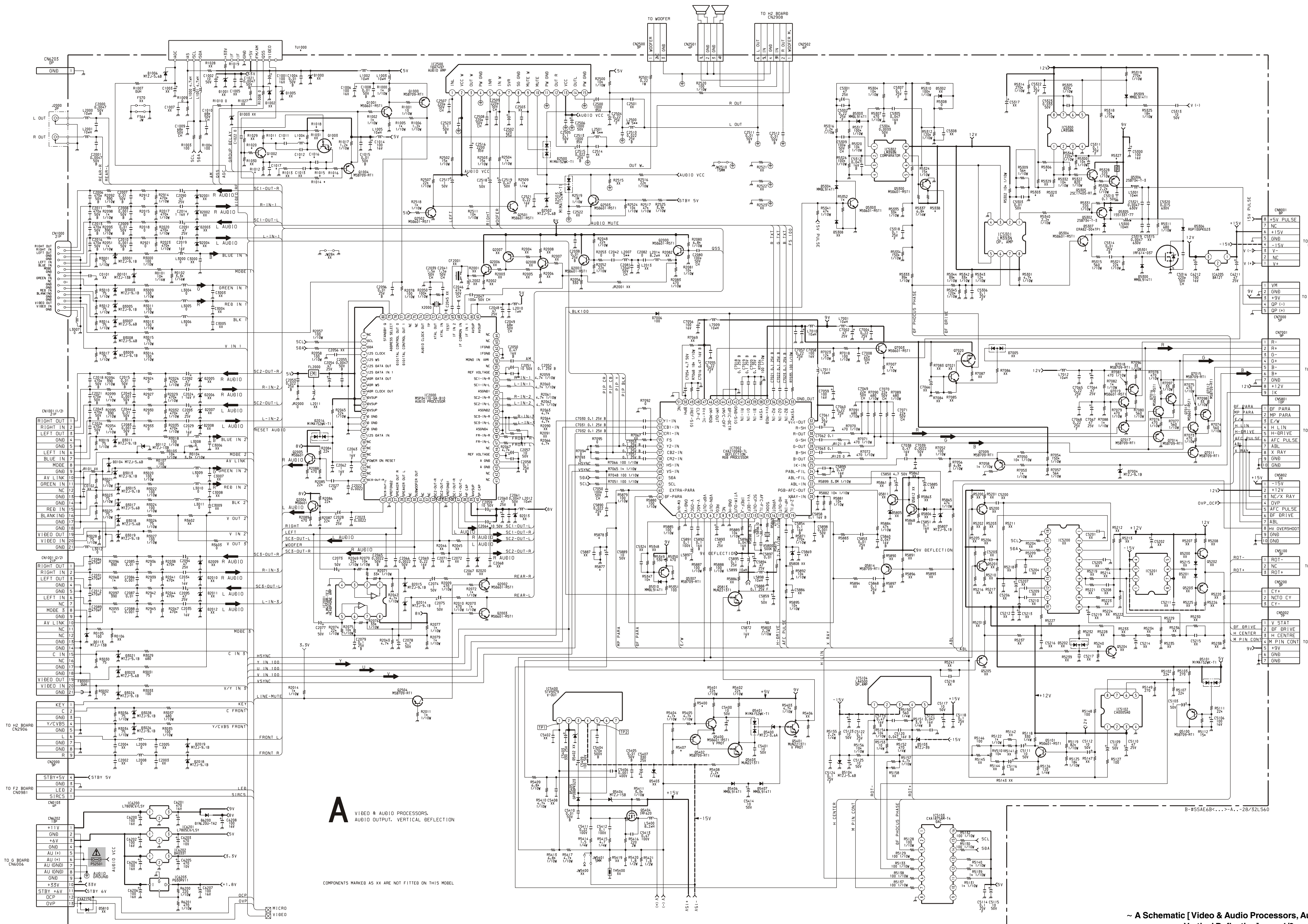

A VIDEO & AUDIO PROCESSORS,
AUDIO OUTPUT, VERTICAL DEFLECTION

COMPONENTS MARKED AS XX ARE NOT FITTED ON THIS MODEL

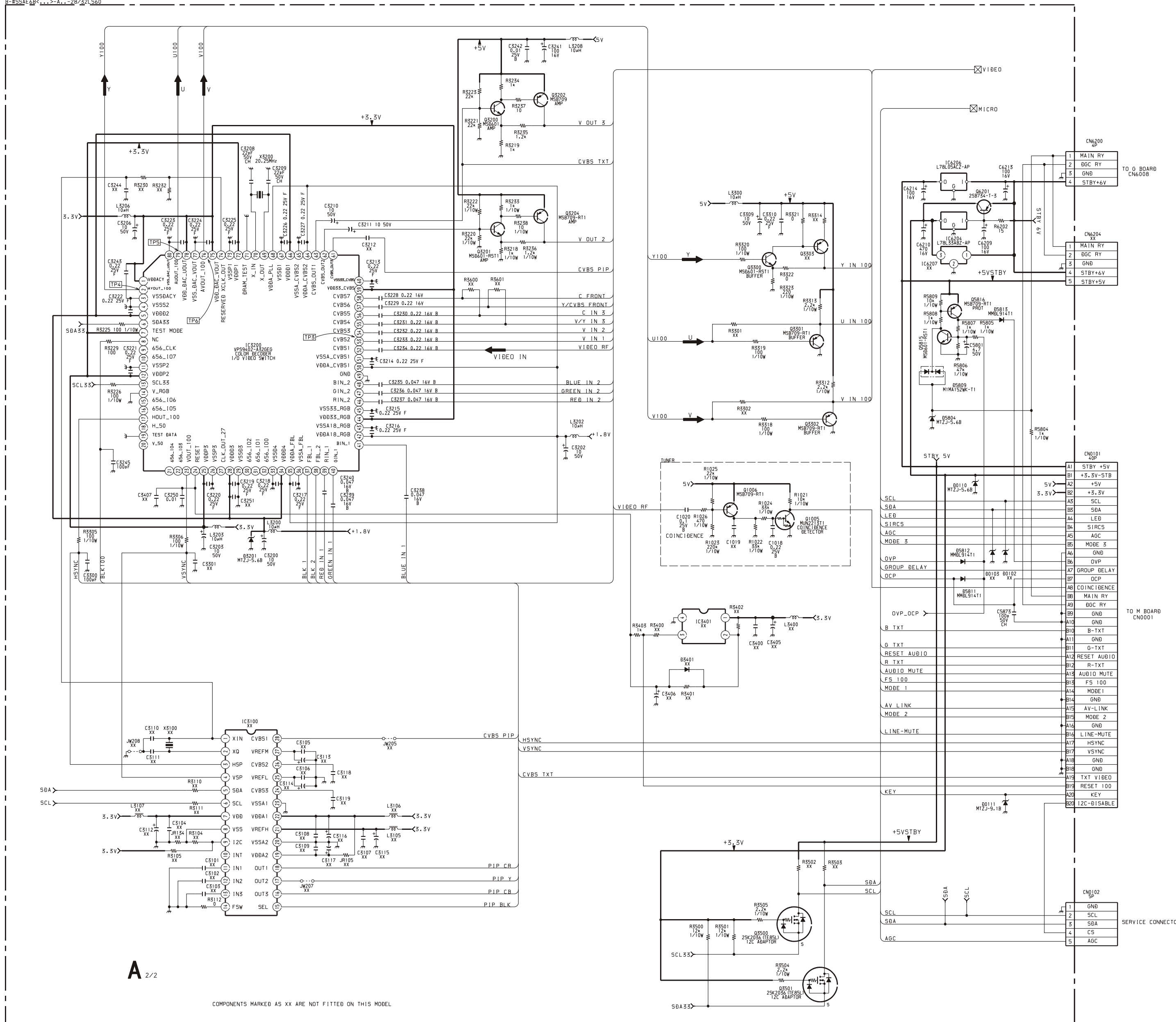

A 2/2

COMPONENTS MARKED AS XX ARE NOT FITTED ON THIS MODEL

~ A Board Waveforms ~

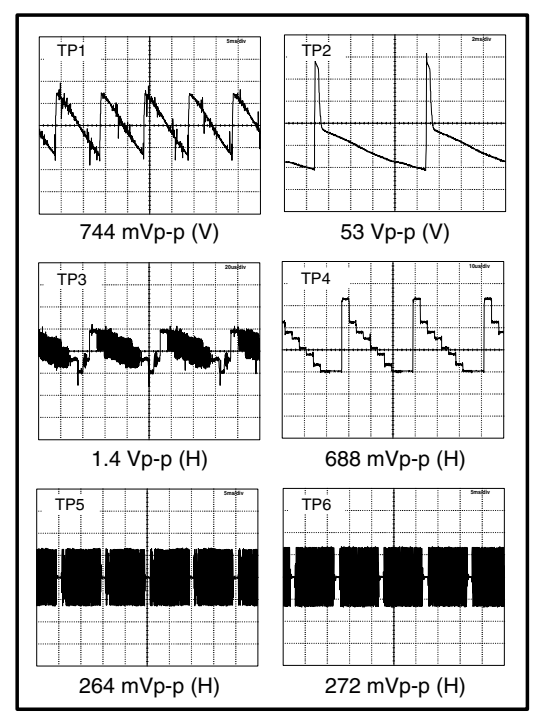

~ A Board Difference Table ~

Ref	28LS60B	28LS60E	28LS60U	32LS60B	32LS60E	32LS60K	32LS60U
C1011	120PF 5% 50V	-	-	120PF 5% 50V	-	-	-
C1012	56PF 5% 50V	-	-	56PF 5% 50V	-	-	-
C1016	10PF 0.50PF 50V	-	-	10PF 0.50PF 50V	-	-	-
C1017	68PF 5% 50V	-	-	68PF 5% 50V	-	-	-
L1004	18UH	-	-	18UH	-	-	-
Q1002	MSD601-RST1	-	-	MSD601-RST1	-	-	-
Q1003	DTC114EK	-	-	DTC114EK	-	-	-
R1011	330 5% 1/10W	-	-	330 5% 1/10W	-	-	-
R1012	330 5% 1/10W	-	-	330 5% 1/10W	-	-	-
R1014	-	SHORT 0	SHORT 0	-	SHORT 0	SHORT 0	SHORT 0
R1015	470 5% 1/10W	-	-	470 5% 1/10W	-	-	-
R1016	100 5% 1/10W	-	-	100 5% 1/10W	-	-	-
R1018	2.2K 5% 1/10W	-	-	2.2K 5% 1/10W	-	-	-
R1020	SHORT 0	-	-	SHORT 0	-	-	-
R5303	56K 0.5% 1/10W	56K 0.5% 1/10W	56K 0.5% 1/10W	27K 0.5% 1/10W	27K 0.5% 1/10W	27K 0.5% 1/10W	27K 0.5% 1/10W
R5306	6.8K 0.5% 1/10W	6.8K 0.5% 1/10W	6.8K 0.5% 1/10W	7.5K 0.5% 1/10W	7.5K 0.5% 1/10W	7.5K 0.5% 1/10W	7.5K 0.5% 1/10W
R5327	82 5% 3W	82 5% 3W	82 5% 3W	39 5% 3W	39 5% 3W	39 5% 3W	39 5% 3W
R5338	1K 5% 1/4W	1K 5% 1/4W	1K 5% 1/4W	470 5% 1/4W	470 5% 1/4W	470 5% 1/4W	470 5% 1/4W
R5407	560K 5% 1/10W	560K 5% 1/10W	560K 5% 1/10W	1M 5% 1/10W	1M 5% 1/10W	1M 5% 1/10W	1M 5% 1/10W
R5878	820 5% 1/10W	820 5% 1/10W	820 5% 1/10W	1K 5% 1/10W	1K 5% 1/10W	1K 5% 1/10W	1K 5% 1/10W
R5883	2.2M 5% 1/10W	2.2M 5% 1/10W	2.2M 5% 1/10W	680K 5% 1/10W	680K 5% 1/10W	680K 5% 1/10W	680K 5% 1/10W
TU1000	BTF-EF411	BTF-EC411	BTF-EU611	BTF-EF411	BTF-EC411	BTF-EA411	BTF-EU611

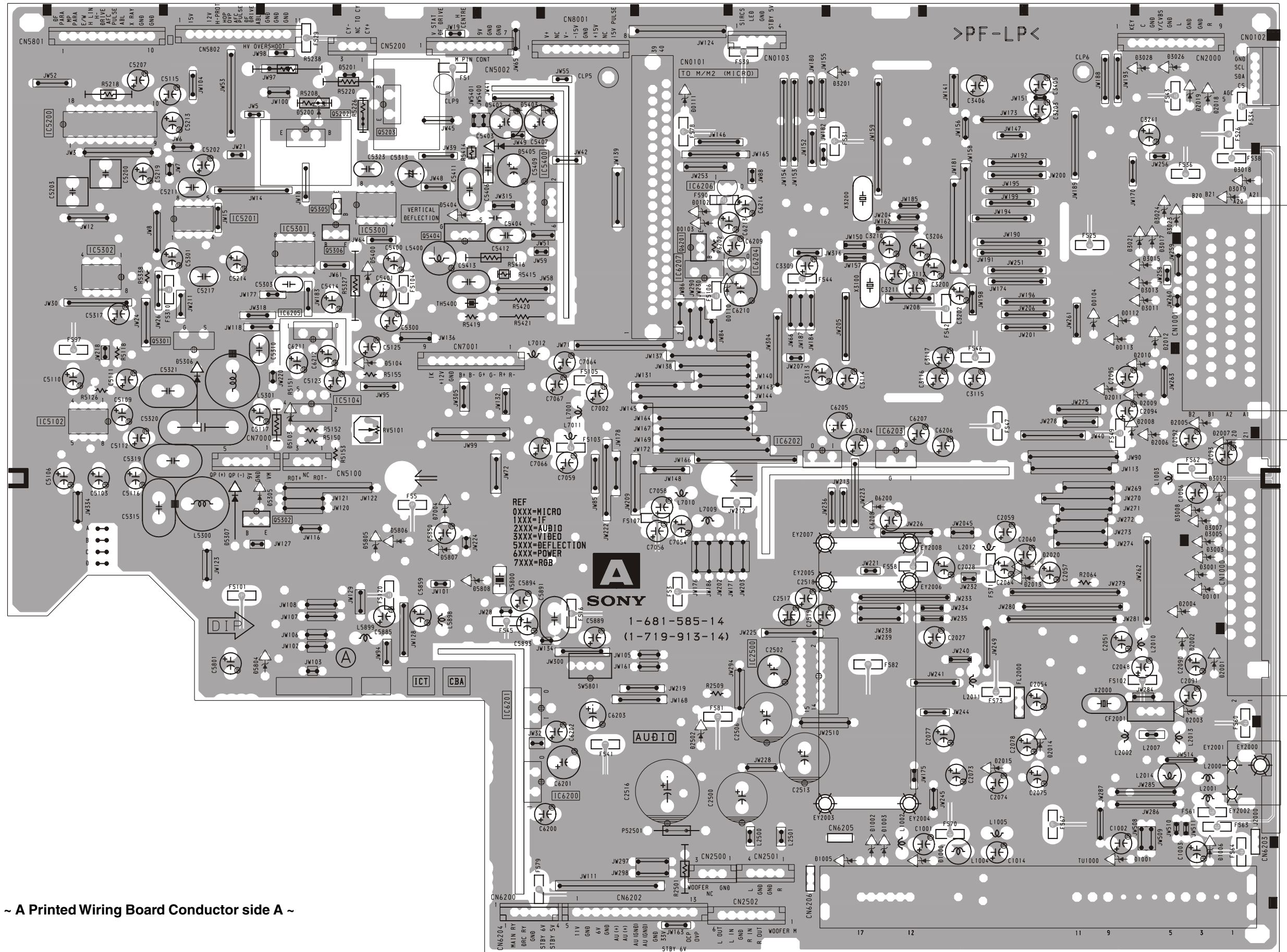

~ A Printed Wiring Board Conductor side A ~

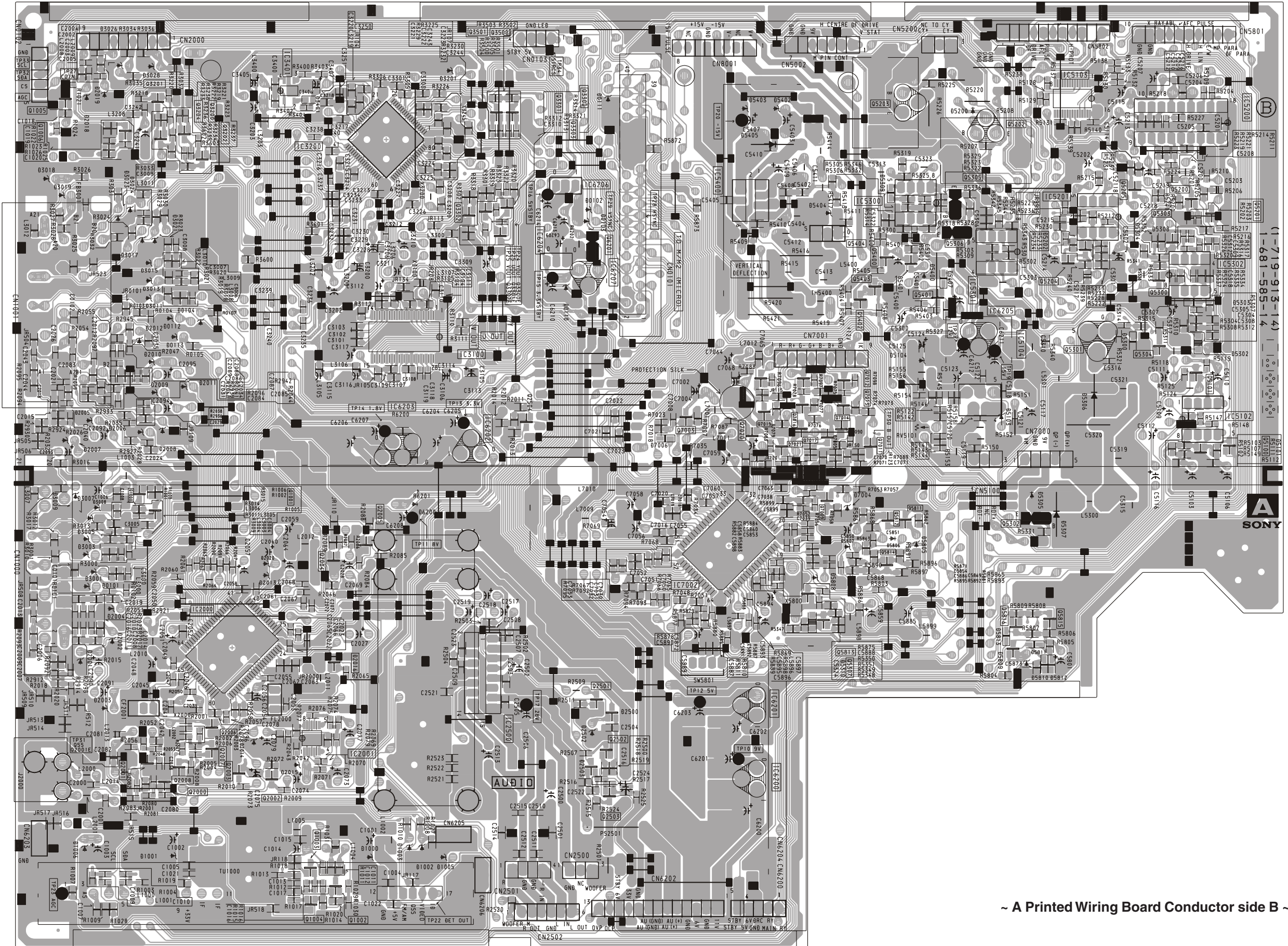

(1-719-913-14)
1-681-585-14

SONY

~ A Printed Wiring Board Conductor side B ~

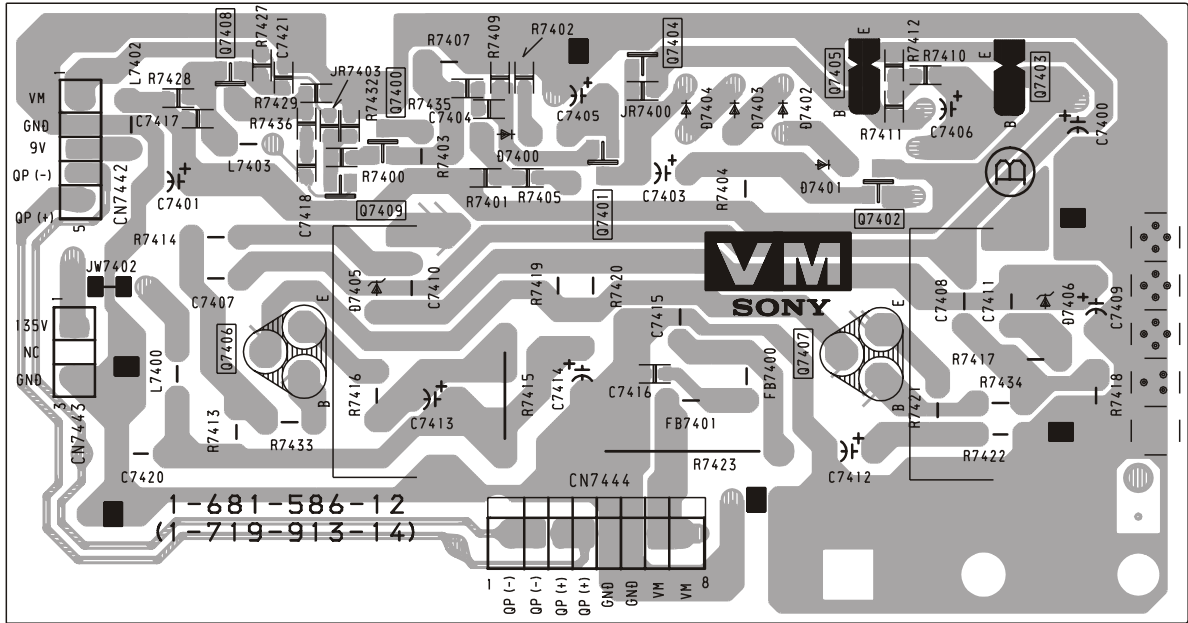

~ VM Board Waveforms ~

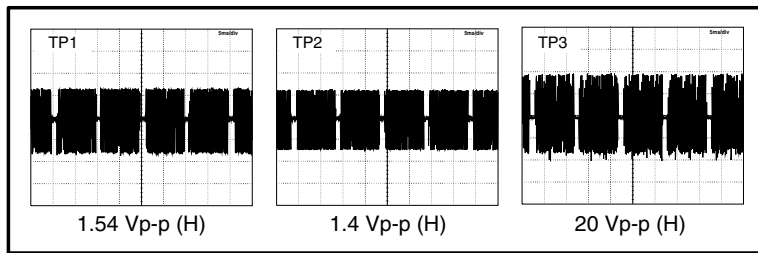

~ VM Board Voltage Table ~

Ref	(e)(s)	(b)(g)	(c)(d)
Q7400	5.0	5.7	8.7
Q7401	0.9	1.5	4.1
Q7402	5.5	6.1	8.9
Q7403	5.1	5.5	8.9
Q7404	4.7	4.1	0
Q7405	5.1	4.7	0
Q7406	134	133.8	68
Q7407	1.1	1.4	68
Q7408	6.3	5.6	2.5
Q7409	5.7	6.3	0.9

~ A Board Location Table (A Side) ~

DIODE	D2014	K - 9	D3005	M - 7	D3017	M - 4	D3028	M - 2	D5306	C - 5	D7004	F - 7	IC5301	D - 4	IC6206	H - 3	
D0101	M - 7	D2015	K - 9	D3007	M - 7	D3018	N - 3	D3201	J - 2	D5307	C - 6	D5809	K - 8	IC5302	B - 4	IC6207	H - 4
D0104	L - 4	D2018	M - 2	D3008	M - 7	D3019	N - 3	D5103	D - 6	D5400	E - 4	IC		IC5400	G - 4	TRANSISTOR	
D0110	I - 4	D2019	M - 2	D3009	N - 7	D3021	M - 4	D5104	E - 5	D5404	F - 3	IC5104	D - 6	IC6201	G - 10	Q5202	E - 2
D0111	H - 2	D2502	H - 9	D3011	M - 4	D3023	M - 4	D5200	D - 2	D5405	F - 3	IC5200	B - 3	IC6202	I - 6	Q5301	C - 5
D0112	M - 4	D3001	M - 7	D3013	M - 4	D3024	M - 4	D5201	E - 2	D5807	F - 7	IC5201	C - 4	IC6203	J - 6	Q5306	E - 4
D0113	M - 5	D3003	M - 7	D3015	M - 4	D3026	M - 2	D5305	D - 6	D6200	J - 6	IC5300	E - 4	IC6205	D - 5	Q5404	F - 4
D1006	M - 10																

~ A Board Location Table (B Side) ~

DIODE	D2503	G - 9	D3024	B - 3	D5309	J - 3	IC5103	L - 3	TRANSISTOR		Q3201	C - 2	Q5300	M - 4	Q7003	H - 6	
D0101	B - 7	D3001	B - 7	D3026	B - 2	D5400	K - 4	IC5104	K - 6	Q1000	C - 6	Q3202	C - 3	Q5301	L - 5	Q7009	K - 6
D0104	C - 5	D3003	B - 7	D3028	C - 2	D5401	J - 4	IC5200	M - 3	Q1001	D - 6	Q3204	C - 3	Q5302	K - 7	Q7011	J - 6
D0110	G - 4	D3005	B - 7	D3201	F - 2	D5404	J - 3	IC5201	L - 4	Q1004	D - 10	Q3300	F - 3	Q5303	M - 4	Q7012	J - 5
D0111	G - 2	D3007	B - 6	D5103	L - 6	D5405	I - 3	IC5300	J - 3	Q1005	B - 2	Q3301	F - 3	Q5304	M - 5	Q7013	J - 6
D0112	C - 5	D3008	B - 6	D5104	J - 5	D5809	K - 8	IC5301	K - 4	Q1006	B - 3	Q3302	F - 3	Q5305	K - 3	Q7014	J - 6
D0113	C - 5	D3009	B - 6	D5200	K - 2	D5811	L - 8	IC5302	M - 4	Q2000	C - 9	Q3500	F - 3	Q5306	K - 4	Q7015	I - 5
D1006	B - 10	D3011	C - 4	D5202	L - 4	D5812	L - 8	IC5400	I - 3	Q2002	D - 9	Q3501	F - 3	Q5400	J - 4	Q7016	I - 5
D2014	C - 9	D3013	C - 4	D5300	L - 5	D6200	F - 7	IC6200	I - 9	Q2003	D - 9	Q5101	M - 5	Q5401	K - 4	Q7017	I - 6
D2015	D - 9	D3015	C - 4	D5303	N - 4	IC		IC6201	I - 8	Q2004	E - 7	Q5200	M - 4	Q5402	J - 5	Q7018	I - 5
D2016	E - 8	D3017	B - 4	D5304	M - 4	IC2000	C - 8	IC6202	F - 6	Q2005	E - 7	Q5201	N - 3	Q5403	J - 4	Q7019	I - 5
D2018	B - 2	D3018	B - 3	D5305	L - 6	IC2001	D - 9	IC6203	E - 6	Q2501	G - 8	Q5202	K - 3	Q5404	J - 4		
D2019	B - 2	D3019	B - 3	D5306	L - 5	IC2500	F - 8	IC6205	K - 5	Q2502	G - 9	Q5203	J - 2	Q5813	J - 8		
D2500	G - 9	D3021	C - 4	D5307	L - 7	IC3100	E - 5	IC6206	G - 3	Q2503	G - 9	Q5204	L - 4	Q5815	L - 8		
D2502	G - 9	D3023	B - 3	D5308	M - 4	IC3200	E - 3	IC6207	G - 4	Q3200	C - 3	Q5205	M - 3	Q5816	L - 8		

~ A Board Semiconductor Voltage Table ~

Ref	(s)	(g)	(d)	Ref	(e)	(b)	(c)	Ref	(e)	(b)	(c)	Ref	(e)	(b)	(c)	Ref	(e)	(b)	(c)	Ref	(e)	(b)	(c)
Q3500	2.7	3.3	3.9	Q2002	0	0	4	Q3204	5	4.4	3.4	Q5205	1.9	1.2	0	Q5813	0	7.9	0	Q7015	11.6	10.9	8.8
Q3501	2.7	3.3	4	Q2003	0	0	4	Q3300	0.7	1.3	5	Q5300	0	0.4	2.2	Q5814	0	0	0	Q7016	6	6.6	10.9
Q5301	0	5.1	51.2	Q2004	3.3	3.9	8.3	Q3301	1.9	1.2	0	Q5301	5.1	0	51.2	Q5815	0	0	5	Q7017	2.7	2	0
Q5404	0	0	0.5	Q2005	3.3	3.9	8.3	Q3302	1.9	1.2	0	Q5302	8.9	5.7	0	Q5816	5	5	0	Q7018	11.6	10.9	8.6
Ref	(e)	(b)	(c)	Q2501	0	0	15.2	Q3500	3.3	2.7	3.9	Q5304	0	0.4	5.6	Q7003	5.6	6.2	8.8	Q7019	6	6.6	10.9
Q1001	3.2	3.9	8.3	Q2502	0	0.7	0	Q3501	3.3	2.7	4	Q3400	0	0	0.1	Q7009	3.2	7	0.1	Q7020	8.9	8.9	0
Q1004	1.9	1.3	0	Q2503	0.6	0.6	0.5	Q5101	0	0.4	6.4	Q5401	0	0	7.9	Q7011	2.5	1.9	0	Q7021	2.7	2.7	8.9
Q1005	0	0.5	5	Q3200	1.9	2.5	4.4	Q5201	2.8	3.4	7.9	Q5402	0	0	-11.3	Q7012	11.6	10.9	8.7				
Q1006	5	4.7	1	Q3201	1.9	2.5	4.4	Q5202	0.2	0.8	11.7	Q5403	-13.5	-11.2	-8.3	Q7013	6	6.6	10.9				
Q2000	4.2	4.8	8.3	Q3202	5	4.4	3.4	Q5203	0.2	0.8	11.7	Q5404	0	0	0.5	Q7014	2.5	1.8	0				

~ A Board IC Voltage Table ~

IC Voltage Table														
Ref No	Pin No	Voltage (V)	Ref No	Pin No	Voltage (V)	Ref No	Pin No	Voltage (V)	Ref No	Pin No	Voltage (V)	Ref No	Pin No	Voltage (V)
IC3100	1	1.3	IC5103	6	1.8	IC5201	5	9.3	IC5400	6	13.7	IC7002	32	8.9
	2	1.7		7	2		6	0.5		7	1.4		33	0
	3	2.6		8	0		7	12.1		1	3.6		34	4.7
	4	0		9	3.1		8	-14.1		2	0		35	4.7
	5	2.5		10	3	1	6	3		4.4	36		4.7	
	6	3.3		11	5	2	6	4		4.8	37		8.9	
	7	0		12	5	3	6	5		3.5	38		0	
	8	0		13	5	4	0	6		3.4	39		4.8	
	9	1.1		14	0	5	6	7		7.6	40		4.8	
	10	1.1		15	0	6	6	8		0	41		4.8	
	11	0		16	5	7	6	9		0	42		0	
	12	0		1	4.8	8	12	10		0.4	43		0	
	13	0	2	4.9	1	1.7	11	1.8	44	0				
	14	0	3	4.8	2	8.5	12	0.4	45	6.3				
	15	0.5	4	4.8	3	6.5	13	0.9	46	8.9				
	16	0.3	5	5	4	0	14	5	47	8.9				
	17	0.3	6	5	5	6.5	15	2.5	48	6				
	18	0.3	7	5	6	7.1	16	0	49	2.5				
	19	3.3	8	5	7	0.4	17	3	50	4.1				
	20	0	9	4.9	8	12	18	2.7	51	0				
	21	3.3	10	12.1	1	0	19	3.9	52	6				
	22	3.3	11	4.1	2	5.8	20	0	53	5.8				
	23	0	12	5	3	6.3	21	6.1	54	5.8				
	24	3.2	13	5	4	0	22	2.7	55	0.4				
	25	1.2	14	1.9	5	6.6	23	8.8	56	5.8				
	26	3.2	15	1.1	6	6.5	24	0	57	5.8				
	27	2.1	16	0	7	0.4	25	4.3	58	5.8				
	28	0.3	17	0	8	12	26	3.2	59	0.3				
IC5103	1	3.3	IC5201	18	0	IC5302	1	1.4	IC7002	27	5.2	IC7002	60	0
	2	3.3		1	9.3		2	13.2		28	0.3		61	0
	3	1.9		2	3.8		3	-12.5		29	4.9		62	2.9
	4	2.6		3	3.8		4	-15.4		30	3.4		63	3.7
	5	2.5		4	-15.4		5	-0.4		31	5.6			

~ F2 Board Schematic Diagram [Power Switch & Fuse, LED & IR Receiver] ~

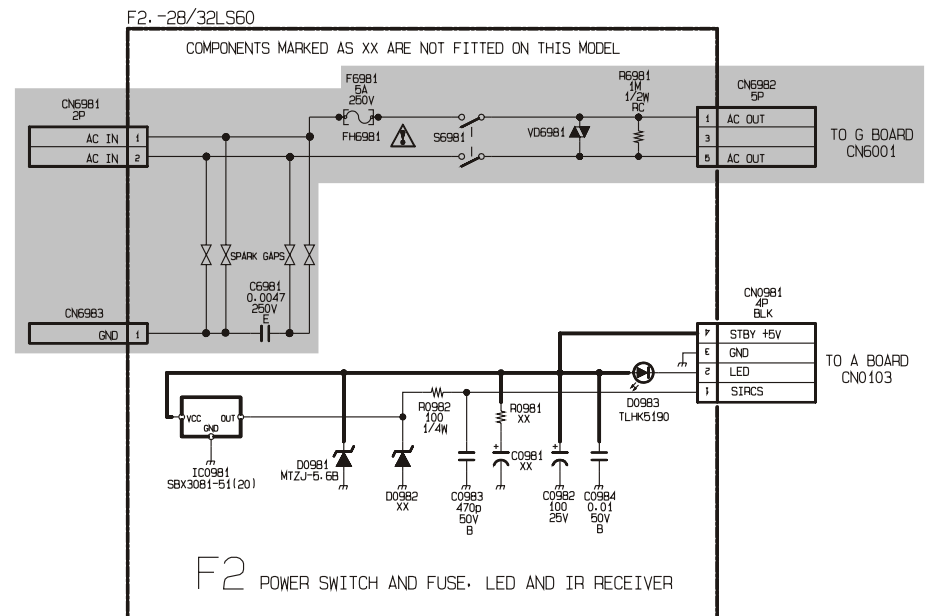

~ H2 Board Schematic Diagram [Front AV & Headphone] ~

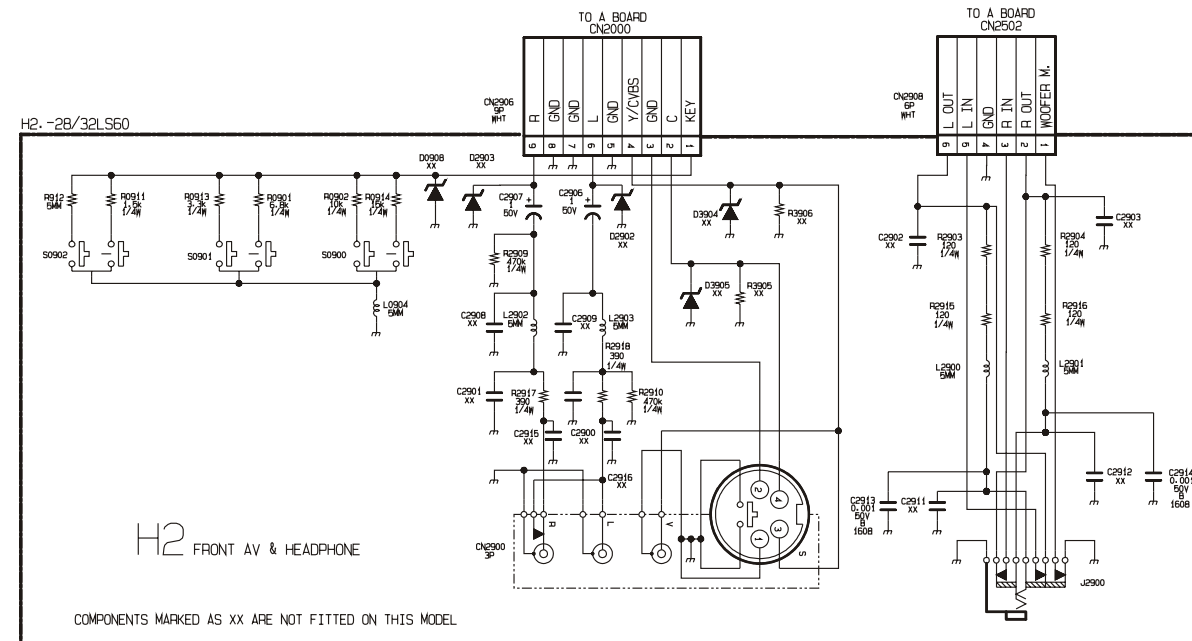

B-#SSAE6B<...>-VM -2B/32LS60

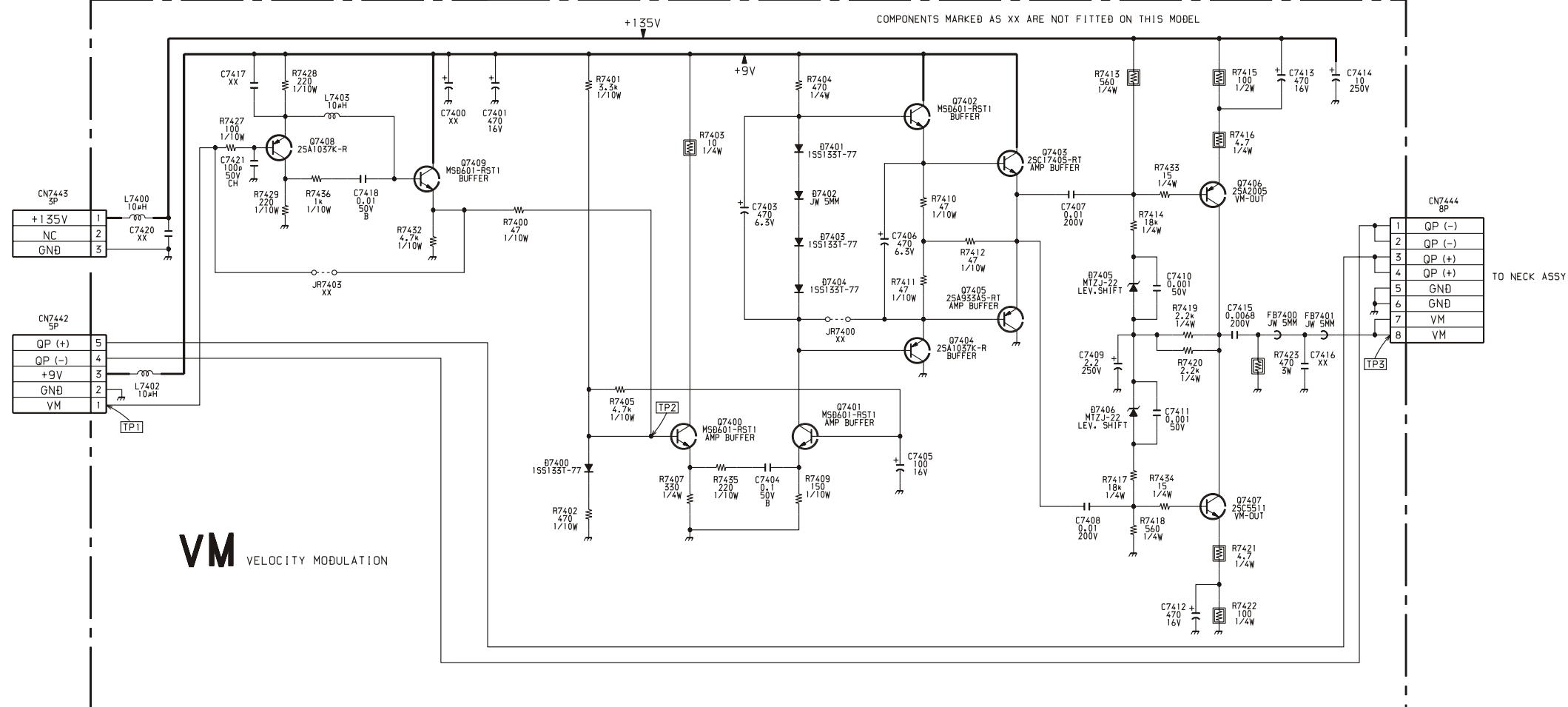

~ VM Board Schematic Diagram [Velocity Modulation] ~

A B C D E F G H I J K L M N

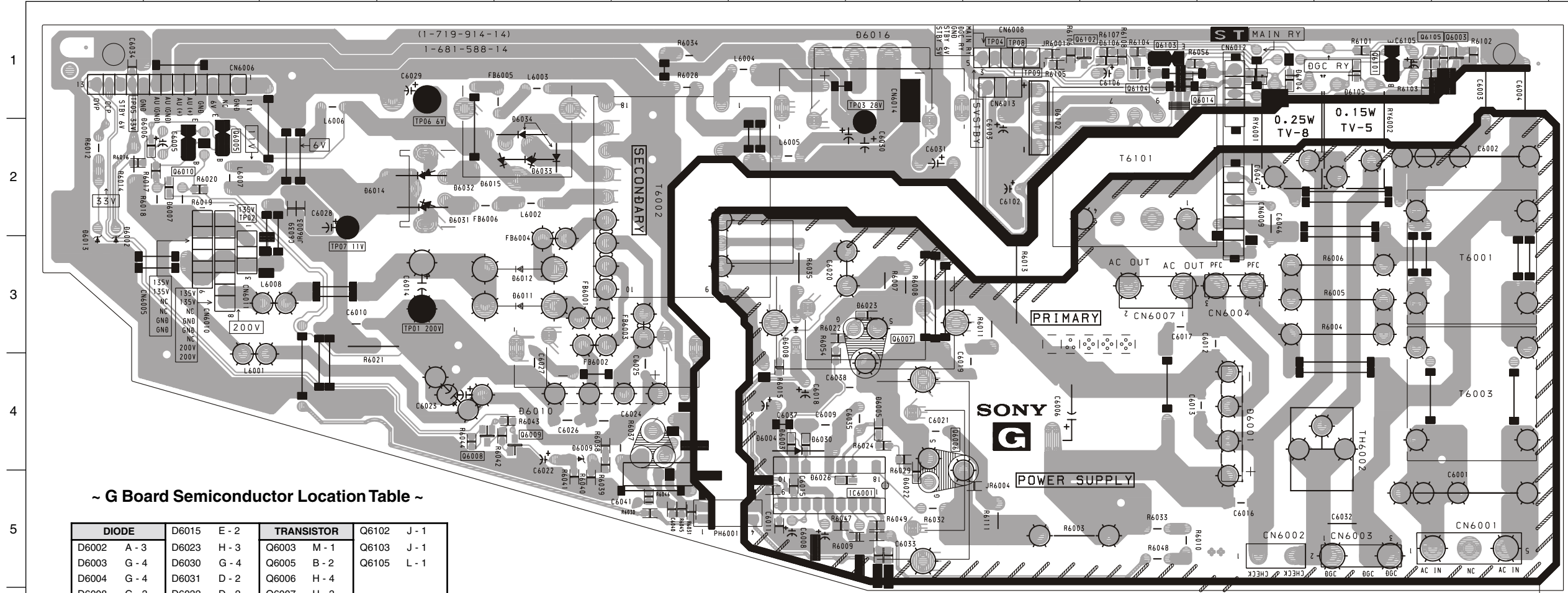

~ G Board Semiconductor Location Table ~

DIODE	D6015 E - 2	TRANSISTOR	Q6102 J - 1
D6002	A - 3	D6023 H - 3	Q6003 M - 1
D6003	G - 4	D6030 G - 4	Q6005 B - 2
D6004	G - 4	D6031 D - 2	Q6006 H - 4
D6008	G - 3	D6032 D - 2	Q6007 H - 3
D6009	E - 4	D6033 E - 2	Q6008 D - 4
D6010	E - 4	D6034 E - 2	Q6009 E - 4
D6011	E - 3	IC	Q6010 B - 2
D6012	E - 3	IC6001 G - 5	Q6014 J - 2
D6013	A - 3		Q6101 L - 1

~ G Printed Wiring Board Conductor side ~

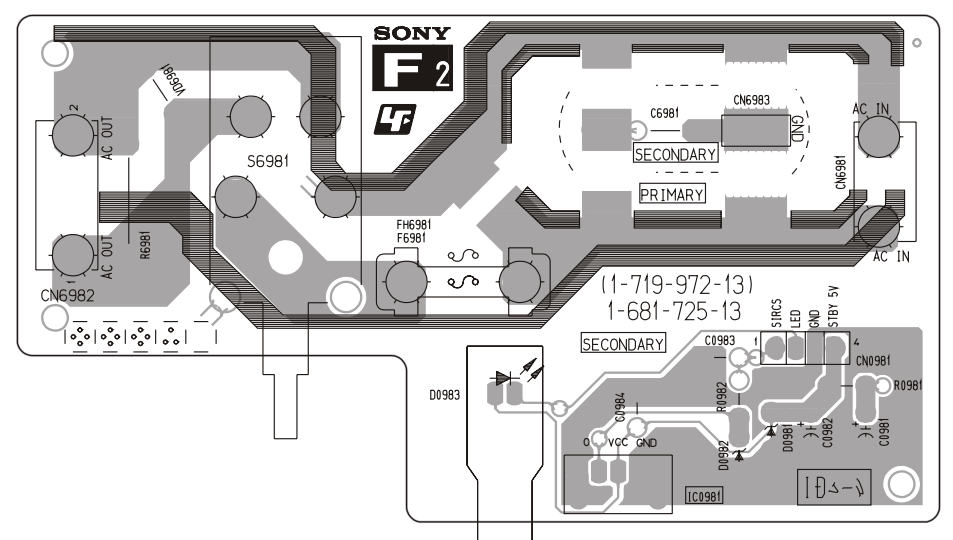

~ F2 Printed Wiring Board Conductor side ~

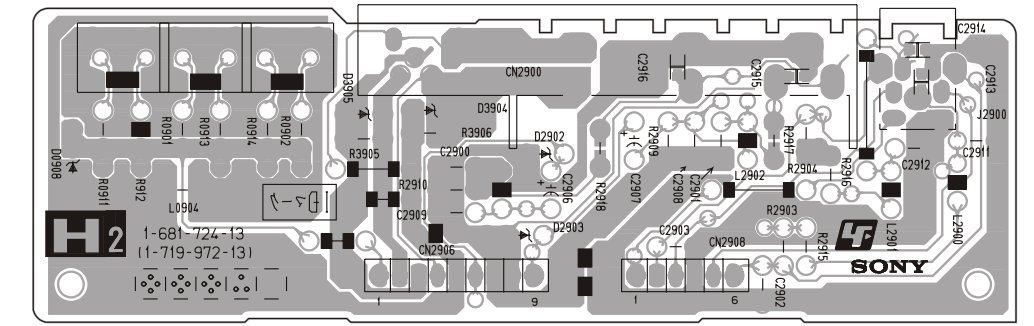

~ H2 Printed Wiring Board Conductor side ~

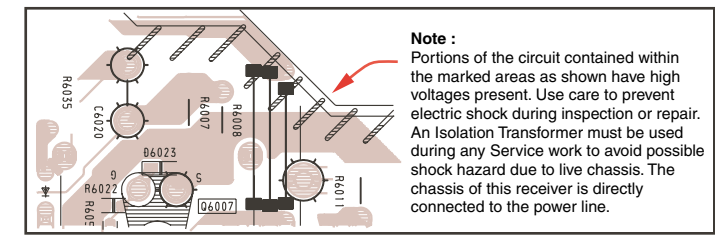

Note :
 Portions of the circuit contained within the marked areas as shown have high voltages present. Use care to prevent electric shock during inspection or repair. An Isolation Transformer must be used during any Service work to avoid possible shock hazard due to live chassis. The chassis of this receiver is directly connected to the power line.

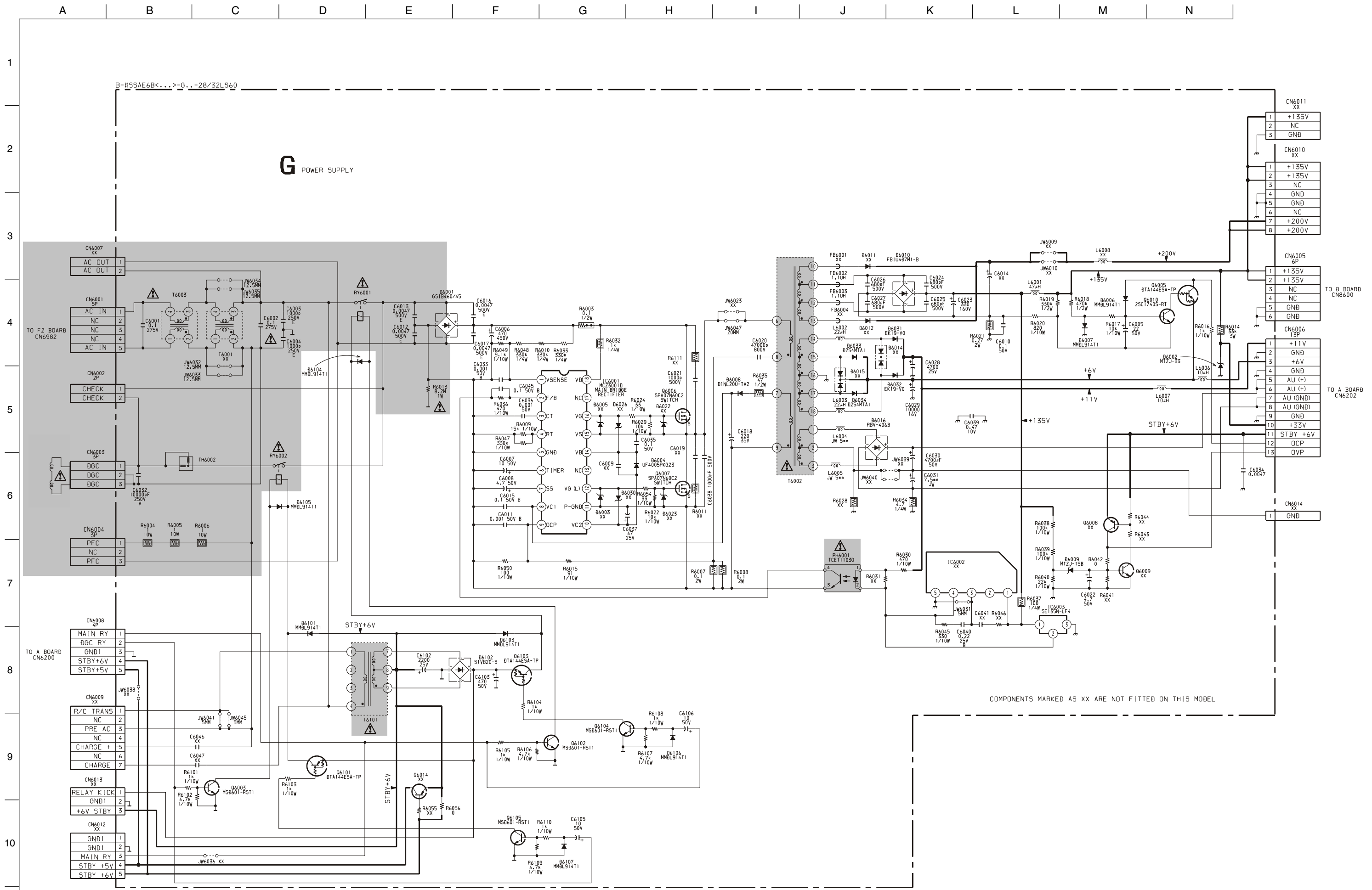

COMPONENTS MARKED AS XX ARE NOT FITTED ON THIS MODEL

~ G Board Schematic Diagram [Power Supply] ~

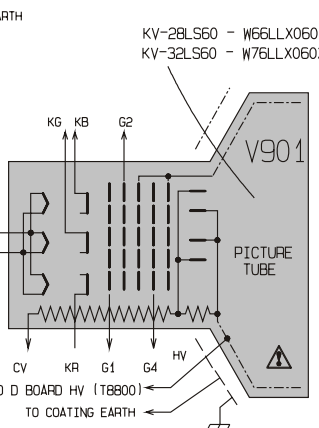
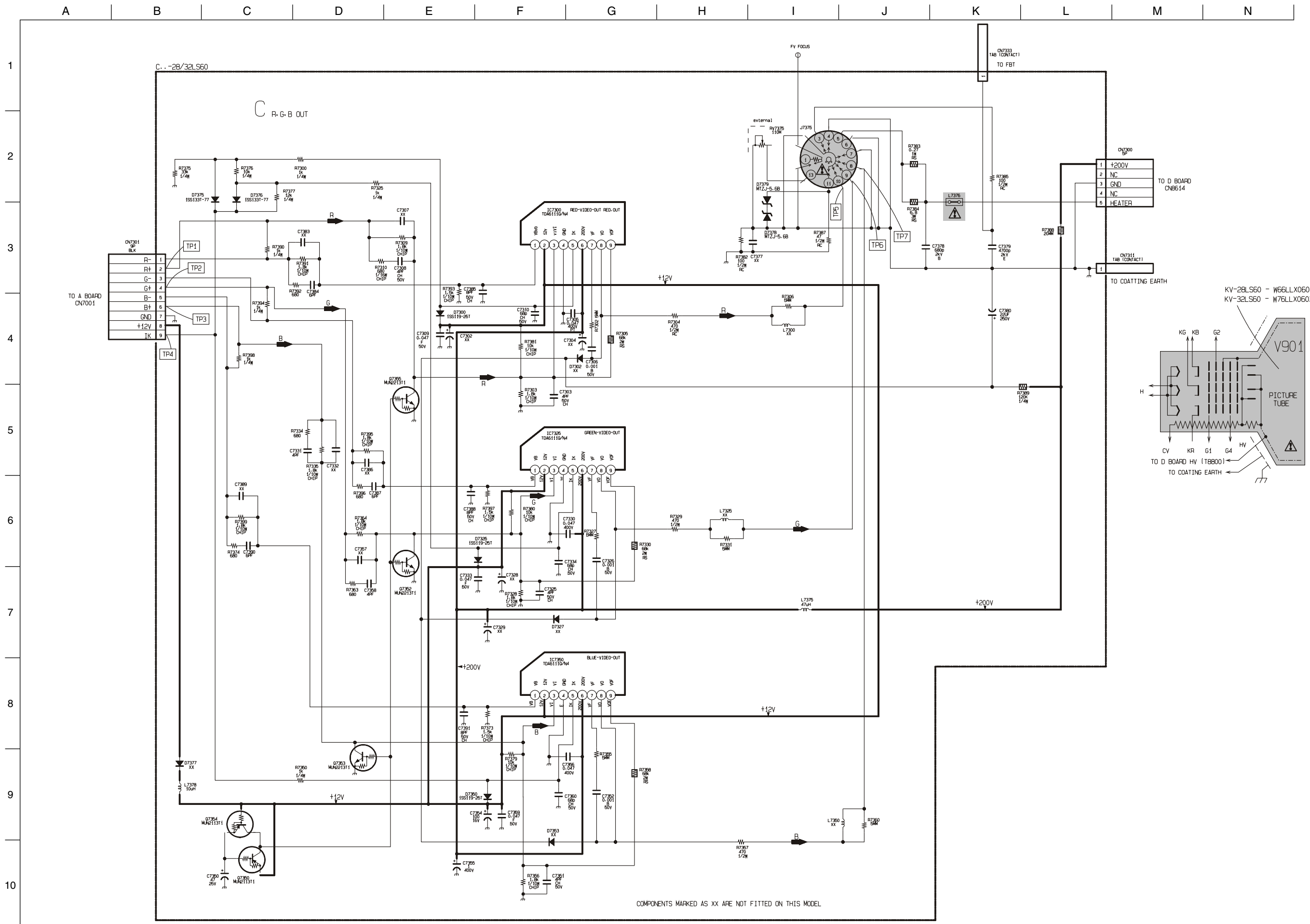

COMPONENTS MARKED AS XX ARE NOT FITTED ON THIS MODEL

~ C Board Schematic Diagram [R-G-B Out] ~

~ C Printed Wiring Board Conductor side ~

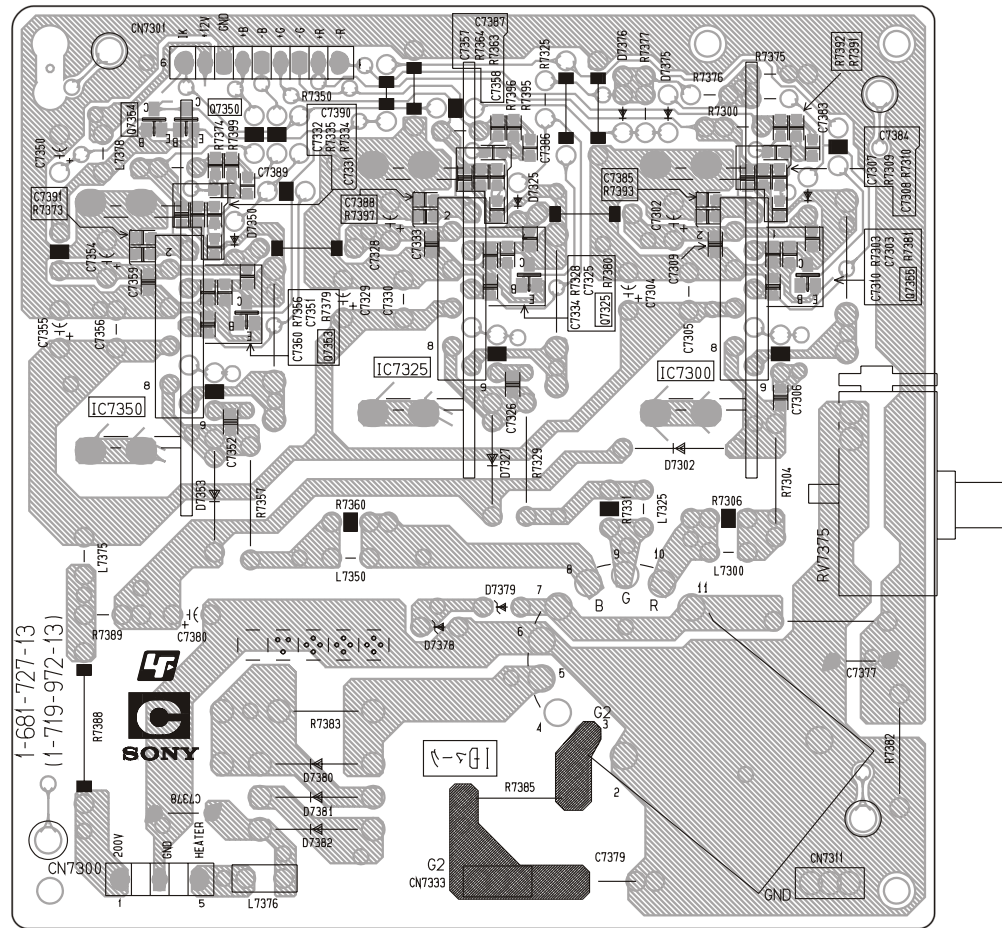

~ C Board Semiconductor Voltage Table ~

Ref	(e)	(b)	(c)
Q7350	12	11.98	0
Q7352	0	0	3.8
Q7353	0	0	3.8
Q7354	11.98	12	0
Q7355	0	0	3.8

~ C Board IC Voltage Table ~

IC Voltage Table		
Ref No	Pin No	Voltage (V)
IC7300	1	3.9
	3	3.8
	5	7.5
	6	200
	7	140
IC7325	1	3.9
	3	3.8
	5	7.7
	6	200
	7	140
IC7350	1	3.9
	3	3.8
	5	7.5
	6	200
	7	139
8	148	
9	138	

~ C Board Waveforms ~

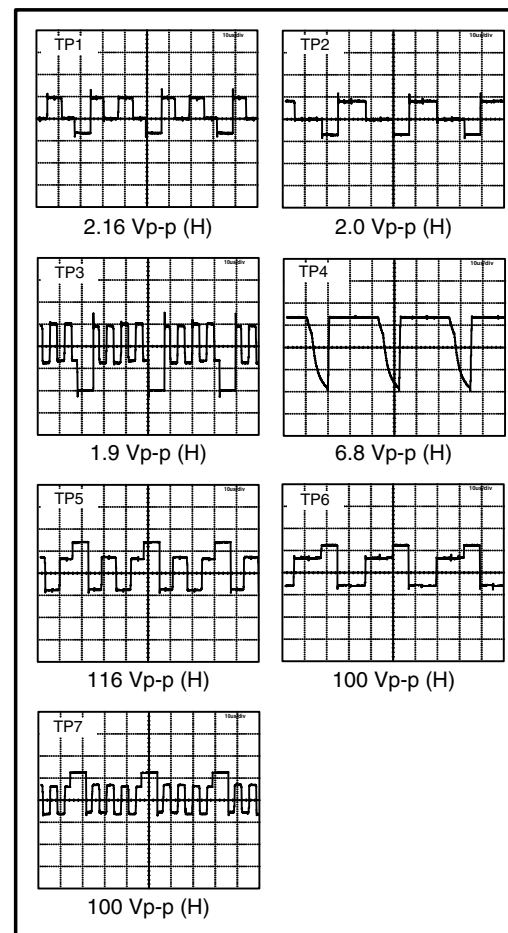

~ M Printed Wiring Board Conductor side A ~

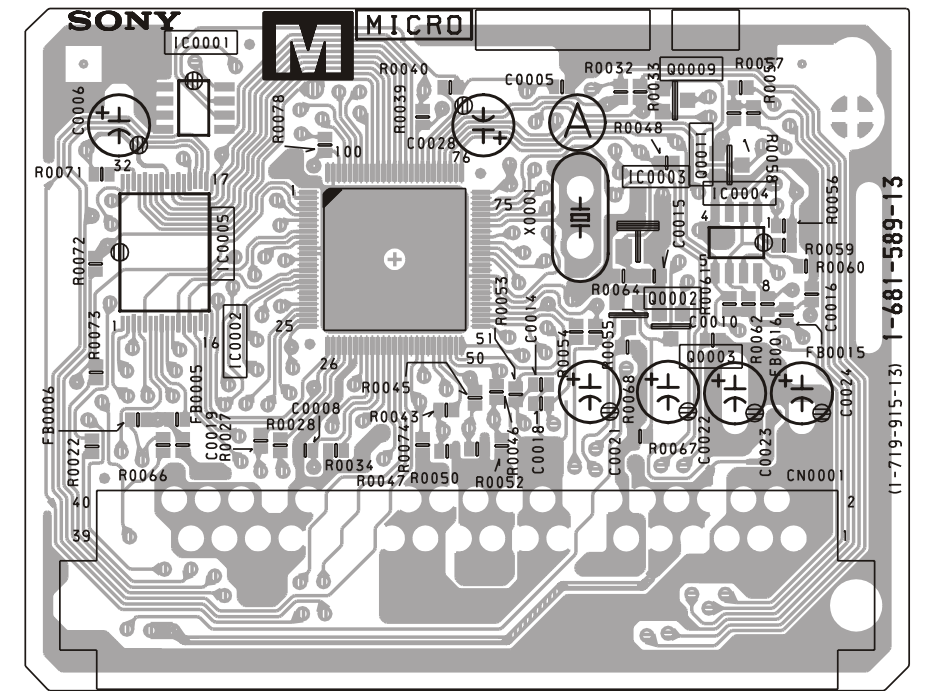

~ M Printed Wiring Board Conductor side B ~

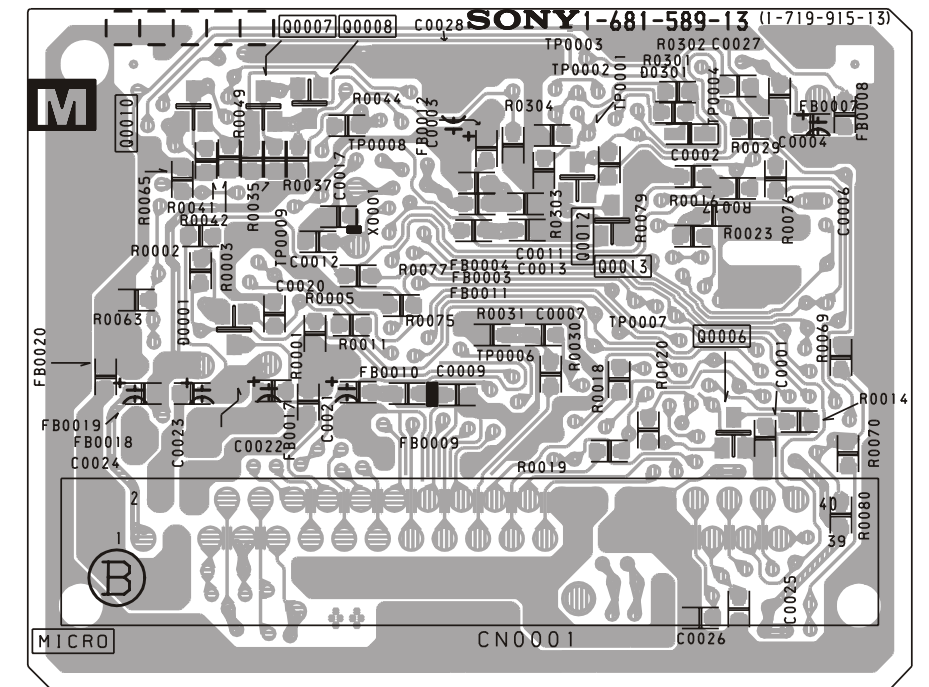

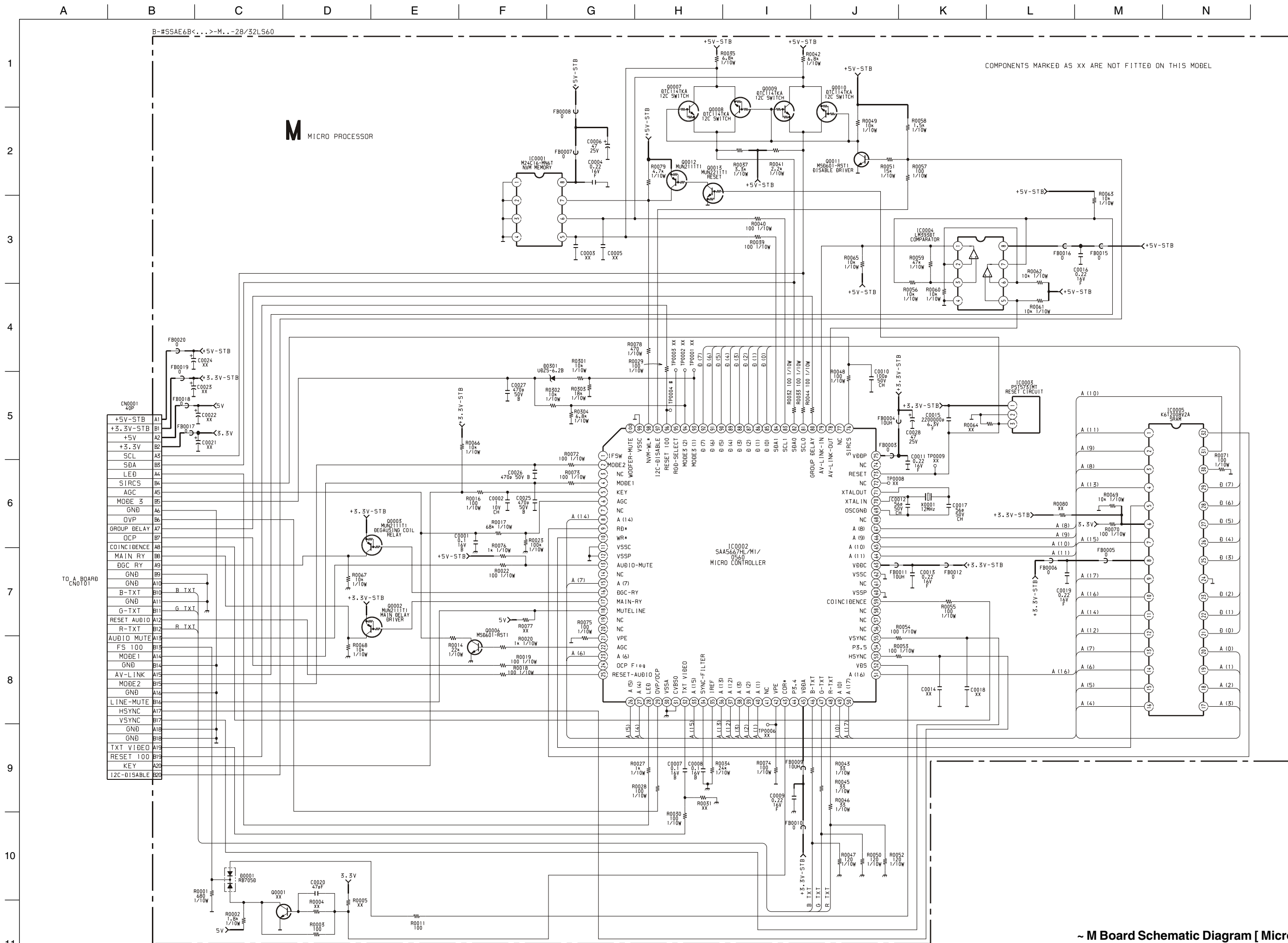

~ M Board Schematic Diagram [Micro Processor] ~

~ D Printed Wiring Board Conductor side ~

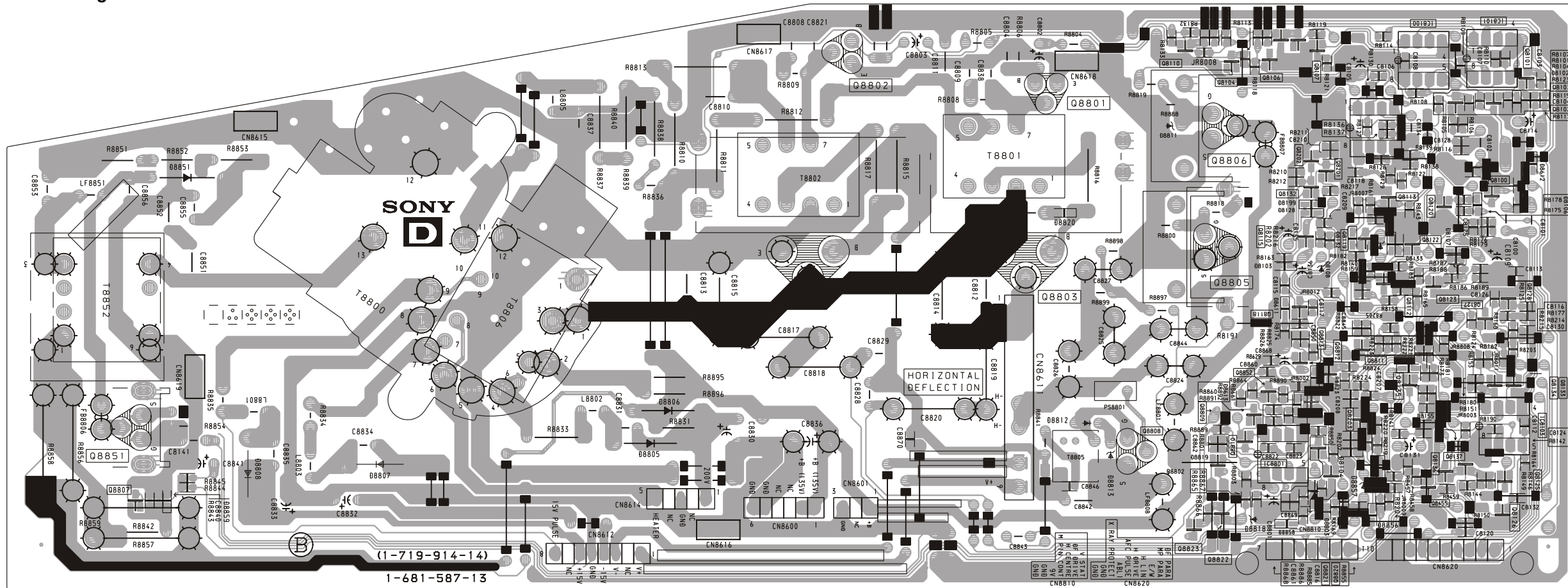

~ D Board Waveforms ~

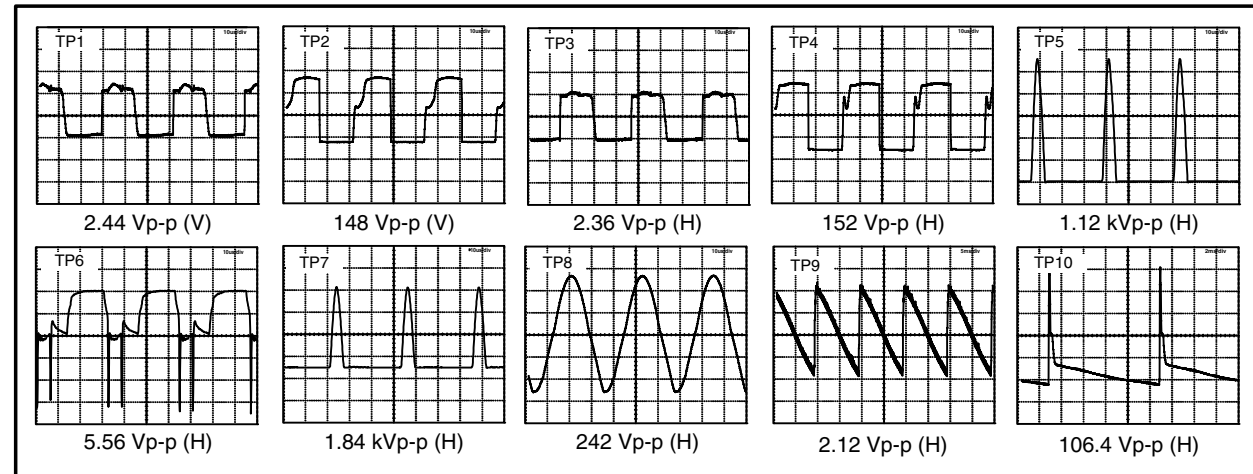

~ D Board IC Voltage Table ~

IC Voltage Table		
Ref No	Pin No	Voltage (V)
IC8100	1	0.3
	2	4.3
	3	4.1
	5	4.1
	6	3.0
	7	0.4
	IC8101	1
2		4.3
3		4.4
5		4.4
6		3.0
7		0.4
IC8102		1
	2	0.4
	3	0.4
	5	0.4
	6	0.4
	7	0.4
	IC8103	1
2		2.1
3		1.7
5		1.6
6		1.0
7		1.1

~ D Board Semiconductor Voltage Table ~

Ref	(e)(s)	(b)(g)	(c)(d)	Ref	(e)(s)	(b)(g)	(c)(d)	Ref	(e)(s)	(b)(g)	(c)(d)	Ref	(e)(s)	(b)(g)	(c)(d)
Q8100	0	0.6	3.6	Q8110	2.4	3.1	0	Q8128	3.4	1.5	8.9	Q8801	0	0.4	64.7
Q8101	0	0.6	4.3	Q8113	0.3	0.2	8.9	Q8132	0	0	3.4	Q8802	0	0.4	73.2
Q8102	0	0.3	4.3	Q8115	8.6	8.9	0	Q8135	2.6	3.2	8.9	Q8807	0	6.3	0
Q8103	4.0	0	8.9	Q8118	0	0	5.0	Q8136	2.5	1.8	0	Q8818	0	0	5.0
Q8104	0	0.4	3.1	Q8119	0.7	1.4	0	Q8137	1.8	2.5	8.9	Q8822	5.5	4.9	0
Q8105	0	0.4	3.2	Q8120	0.7	2.3	0	Q8201	0	0.6	3.9	Q8805	0	2.5	33
Q8106	0	0.3	4.3	Q8122	0.5	1.4	0	Q8202	0	0.8	3.4	Q8803	0	1.2	135
Q8107	0	0.3	4.2	Q8123	0.5	1.4	0	Q8203	1.4	0.9	0	Q8806	0	1.2	135
Q8108	2.4	3.2	0	Q8127	1.4	1.5	0	Q8455	1.1	1.7	8.9	Q8851	0	5.4	81.5

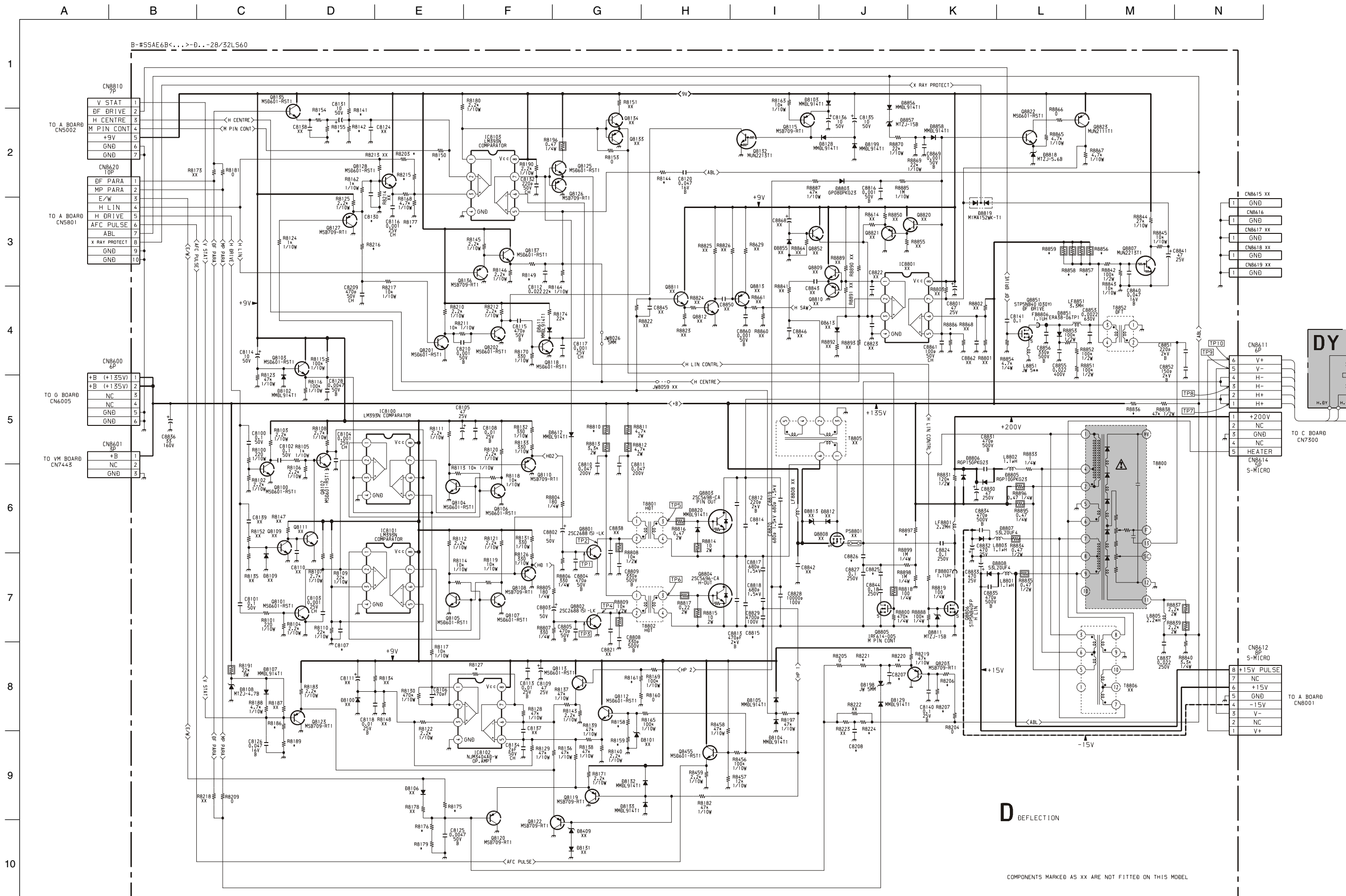

D DEFLECTION

COMPONENTS MARKED AS XX ARE NOT FITTED ON THIS MODEL

~ D Board Schematic Diagram [Deflection] ~

~ D Board Difference Table ~

Ref	28LS60B	28LS60E	28LS60U	32LS60B	32LS60E	32LS60K	32LS60U
C8107	-	-	-	27K 0.5% 1/10W	27K 0.5% 1/10W	27K 0.5% 1/10W	27K 0.5% 1/10W
C8130	220PF 5% 50V	220PF 5% 50V	220PF 5% 50V	-	-	-	-
C8207	-	-	-	0.047UF 10% 16V	0.047UF 10% 16V	0.047UF 10% 16V	0.047UF 10% 16V
C8208	-	-	-	0.01UF 10% 25V	0.01UF 10% 25V	0.01UF 10% 25V	0.01UF 10% 25V
C8814	7500PF 3% 1.2KV	7500PF 3% 1.2KV	7500PF 3% 1.2KV	6800PF 3% 1.2KV	6800PF 3% 1.2KV	6800PF 3% 1.2KV	6800PF 3% 1.2KV
C8815	6800PF 3% 1.5KV	6800PF 3% 1.5KV	6800PF 3% 1.5KV	6200PF 3% 1.5KV	6200PF 3% 1.5KV	6200PF 3% 1.5KV	6200PF 3% 1.5KV
C8825	0.22UF 5% 250V	0.22UF 5% 250V	0.22UF 5% 250V	0.18UF 5% 250V	0.18UF 5% 250V	0.18UF 5% 250V	0.18UF 5% 250V
C8826	0.68UF 5% 250V	0.68UF 5% 250V	0.68UF 5% 250V	0.56UF 5% 250V	0.56UF 5% 250V	0.56UF 5% 250V	0.56UF 5% 250V
R8127	4.7K 0.5% 1/10W	4.7K 0.5% 1/10W	4.7K 0.5% 1/10W	6.8K 0.5% 1/10W	6.8K 0.5% 1/10W	6.8K 0.5% 1/10W	6.8K 0.5% 1/10W
R8141	22K 0.5% 1/10W	22K 0.5% 1/10W	22K 0.5% 1/10W	33K 0.5% 1/10W	33K 0.5% 1/10W	33K 0.5% 1/10W	33K 0.5% 1/10W
R8142	7.5K 0.5% 1/10W	7.5K 0.5% 1/10W	7.5K 0.5% 1/10W	4.7K 0.5% 1/10W	4.7K 0.5% 1/10W	4.7K 0.5% 1/10W	4.7K 0.5% 1/10W
R8144	220K 5% 1/10W	220K 5% 1/10W	220K 5% 1/10W	120K 5% 1/10W	120K 5% 1/10W	120K 5% 1/10W	120K 5% 1/10W
R8149	22K 5% 1/10W	220K 5% 1/10W	220K 5% 1/10W	3.9K 5% 1/10W	3.9K 5% 1/10W	3.9K 5% 1/10W	3.9K 5% 1/10W
R8150	22K 5% 1/10W	22K 5% 1/10W	22K 5% 1/10W	6.8K 5% 1/10W	6.8K 5% 1/10W	6.8K 5% 1/10W	6.8K 5% 1/10W
R8154	5.6K 5% 1/10W	5.6K 5% 1/10W	5.6K 5% 1/10W	3.3K 5% 1/10W	3.3K 5% 1/10W	3.3K 5% 1/10W	3.3K 5% 1/10W
R8155	4.7K 0.5% 1/10W	4.7K 0.5% 1/10W	4.7K 0.5% 1/10W	2.7K 5% 1/10W	2.7K 5% 1/10W	2.7K 5% 1/10W	2.7K 5% 1/10W
R8158	2.2K 0.5% 1/10W	2.2K 0.5% 1/10W	2.2K 0.5% 1/10W	4.7K 0.5% 1/10W	4.7K 0.5% 1/10W	4.7K 0.5% 1/10W	4.7K 0.5% 1/10W
R8159	2.2K 0.5% 1/10W	2.2K 0.5% 1/10W	2.2K 0.5% 1/10W	SHORT 0	SHORT 0	SHORT 0	SHORT 0
R8161	6.8K 0.5% 1/10W	6.8K 0.5% 1/10W	6.8K 0.5% 1/10W	8.2K 0.5% 1/10W	8.2K 0.5% 1/10W	8.2K 0.5% 1/10W	8.2K 0.5% 1/10W
R8175	4.7K 5% 1/10W	4.7K 5% 1/10W	4.7K 5% 1/10W	6.8K 5% 1/10W	6.8K 5% 1/10W	6.8K 5% 1/10W	6.8K 5% 1/10W
R8176	SHORT 0	SHORT 0	SHORT 0	10K 5% 1/10W	10K 5% 1/10W	10K 5% 1/10W	10K 5% 1/10W
R8177	5.6K 5% 1/10W	5.6K 5% 1/10W	5.6K 5% 1/10W	4.7K 5% 1/10W	4.7K 5% 1/10W	4.7K 5% 1/10W	4.7K 5% 1/10W
R8179	4.7K 5% 1/10W	4.7K 5% 1/10W	4.7K 5% 1/10W	SHORT 0	SHORT 0	SHORT 0	SHORT 0
R8186	2.7K 5% 1/10W	2.7K 5% 1/10W	2.7K 5% 1/10W	3.9K 5% 1/10W	3.9K 5% 1/10W	3.9K 5% 1/10W	3.9K 5% 1/10W
R8189	1.5K 5% 1/10W	1.5K 5% 1/10W	1.5K 5% 1/10W	560 5% 1/10W	560 5% 1/10W	560 5% 1/10W	560 5% 1/10W
R8203	6.8K 5% 1/10W	6.8K 5% 1/10W	6.8K 5% 1/10W	SHORT 0	SHORT 0	SHORT 0	SHORT 0
R8206	470K 5% 1/10W	470K 5% 1/10W	470K 5% 1/10W	330K 0.5% 1/10W	330K 0.5% 1/10W	330K 0.5% 1/10W	330K 0.5% 1/10W
R8207	270K 5% 1/10W	270K 5% 1/10W	270K 5% 1/10W	220K 5% 1/10W	220K 5% 1/10W	220K 5% 1/10W	220K 5% 1/10W
R8215	22K 0.5% 1/10W	22K 0.5% 1/10W	22K 0.5% 1/10W	47K 0.5% 1/10W	47K 0.5% 1/10W	47K 0.5% 1/10W	47K 0.5% 1/10W
R8216	47K 5% 1/10W	47K 5% 1/10W	47K 5% 1/10W	47K 0.5% 1/10W	47K 0.5% 1/10W	47K 0.5% 1/10W	47K 0.5% 1/10W
R8220	6.8K 5% 1/10W	6.8K 5% 1/10W	6.8K 5% 1/10W	12K 5% 1/10W	12K 5% 1/10W	12K 5% 1/10W	12K 5% 1/10W
R8221	18K 5% 1/10W	18K 5% 1/10W	18K 5% 1/10W	22K 5% 1/10W	22K 5% 1/10W	22K 5% 1/10W	22K 5% 1/10W
R8224	-	-	-	3.3K 5% 1/10W	3.3K 5% 1/10W	3.3K 5% 1/10W	3.3K 5% 1/10W
R8810	4.7K 5% 2W	4.7K 5% 2W	4.7K 5% 2W	3.9K 5% 2W	3.9K 5% 2W	3.9K 5% 2W	3.9K 5% 2W
R8836	18K 5% 1/4W	18K 5% 1/4W	18K 5% 1/4W	15K 5% 1/4W	15K 5% 1/4W	15K 5% 1/4W	15K 5% 1/4W
R8856	8.2K 5% 3W	8.2K 5% 3W	8.2K 5% 3W	6.8K 5% 3W	6.8K 5% 3W	6.8K 5% 3W	6.8K 5% 3W
R8857	8.2K 5% 3W	8.2K 5% 3W	8.2K 5% 3W	6.8K 5% 3W	6.8K 5% 3W	6.8K 5% 3W	6.8K 5% 3W
R8858	8.2K 5% 3W	8.2K 5% 3W	8.2K 5% 3W	6.8K 5% 3W	6.8K 5% 3W	6.8K 5% 3W	6.8K 5% 3W
R8859	8.2K 5% 3W	8.2K 5% 3W	8.2K 5% 3W	6.8K 5% 3W	6.8K 5% 3W	6.8K 5% 3W	6.8K 5% 3W
R8886	220K 0.5% 1/10W	220K 0.5% 1/10W	220K 0.5% 1/10W	220K 5% 1/10W	220K 5% 1/10W	220K 5% 1/10W	220K 5% 1/10W
R8897	470K 1% 1/4W	470K 1% 1/4W	470K 1% 1/4W	680K 1% 1/4W	680K 1% 1/4W	680K 1% 1/4W	680K 1% 1/4W
T8800	FBT ASSY NX4522//Z214	FBT ASSY NX4522//Z214	FBT ASSY NX4522//Z214	FBT ASSY NX4522//Z2B4	FBT ASSY NX4522//Z2B4	FBT ASSY NX4522//Z2B4	FBT ASSY NX4522//Z2B4

5-4. SEMICONDUCTORS

CXAB070AP
MCZ3001D

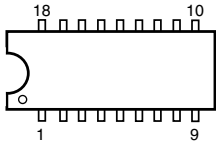

LM318P
LM358N
LM393DT
LM393N
M24C16-MN6T(A)

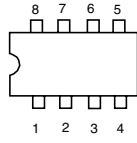

PST573IMT

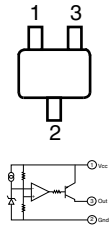

CXA1875AM-T4

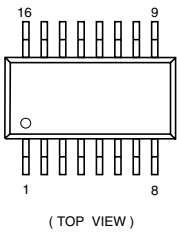

LM78L05ACZ

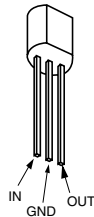

SAA5665HL/M1D/0358

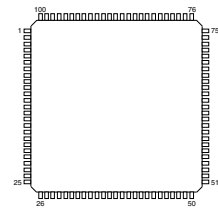

CXA2100AQ-TL

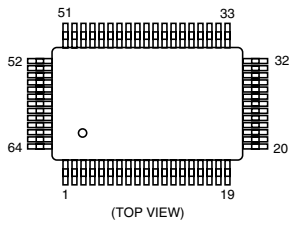

MSP3411G-QA-B10

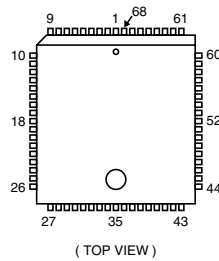

SBX3081-51(30)

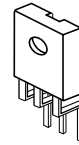

K6T2008V2A-YF70T00

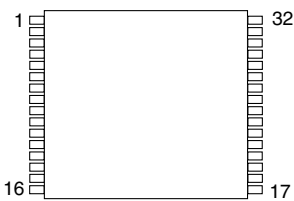

NJM3404AD-W
UPC4558G2

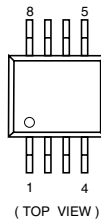

SDA9488X-B23GEG

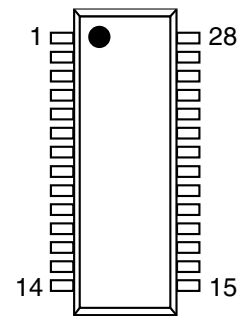

LA6500-FA

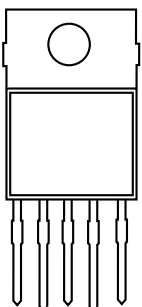

PQ30RV11

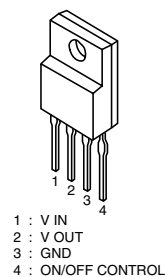

STV9379

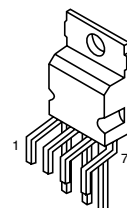

TCET1103G

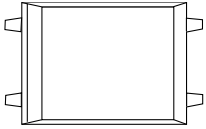

DTA144EK
DTC144TKA-T146
2SA1162-G

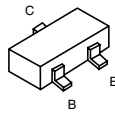

SE135N-LF4

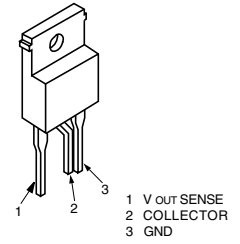

TDA6111Q/N4

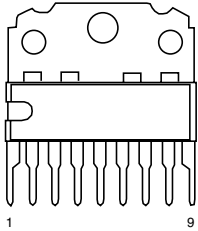

DTA144ESA
2SA933AS-QT
2SC2785-HFE

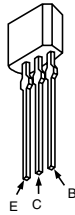

2SA1837(LBS2S0N)

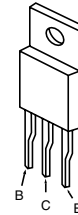

TDA7497

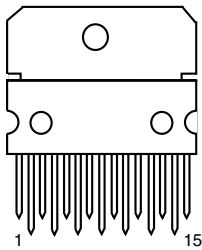

L7809CV/LSY
STP5NB40FP
STP5NB40(030Y)
2SC5698-CA
2S5696-SONY-CA

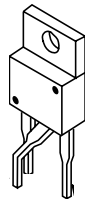

2SB734-34



VPS9402-A32GEG

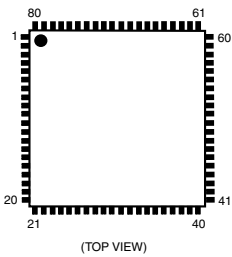

MSB709-RT1
MSD601-RST1
M1MA152WA-T1
UN2111
UN213
2SK2036(TE85L)

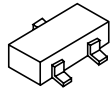

2SC2688(5)-LK

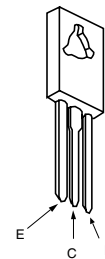

BA12T
BAO33T
IRF614-005
IRF620
SPA07N60C2
2SA2005
2SC5511

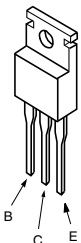

RB705D

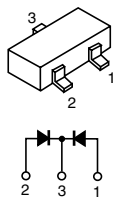

BAS216

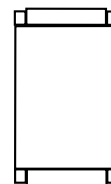

BAS316-115
 MMDL914T1
 UDZSTE-176.2B

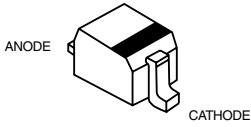

FBIU4D7MA-B
 RBV-406B
 S1VB40

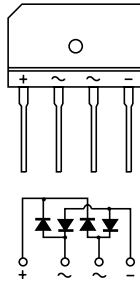

BYV98-200-RAS 15/12

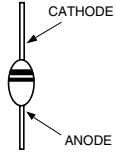

GS1B460/45

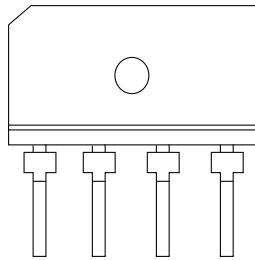

D1NL20U
 EGP20G
 EL1Z
 GP08D
 UF4005PKG23

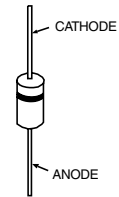

TLHK5190

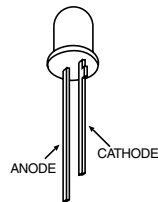

D2S4MTA1

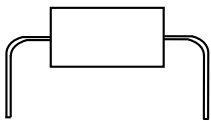

ERA38-06	MTZJ-T-77-22
ERA85-009	RD15ES-B2
HZS9.1NB2	RD39ES-B2
MTZJ-13B	RD5.6ESB2
MTZJ-33B	1SS119-25
MTZJ-3.6A	1SS133T-77
MTZJ-4.7C	

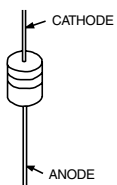

5-5 IC BLOCK DIAGRAMS

A BOARD IC6202/IC6205 BA033T/BA12T

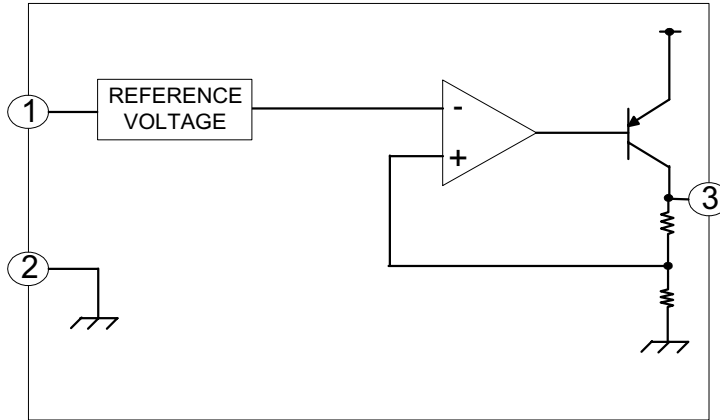

A BOARD IC2500 TDA7497

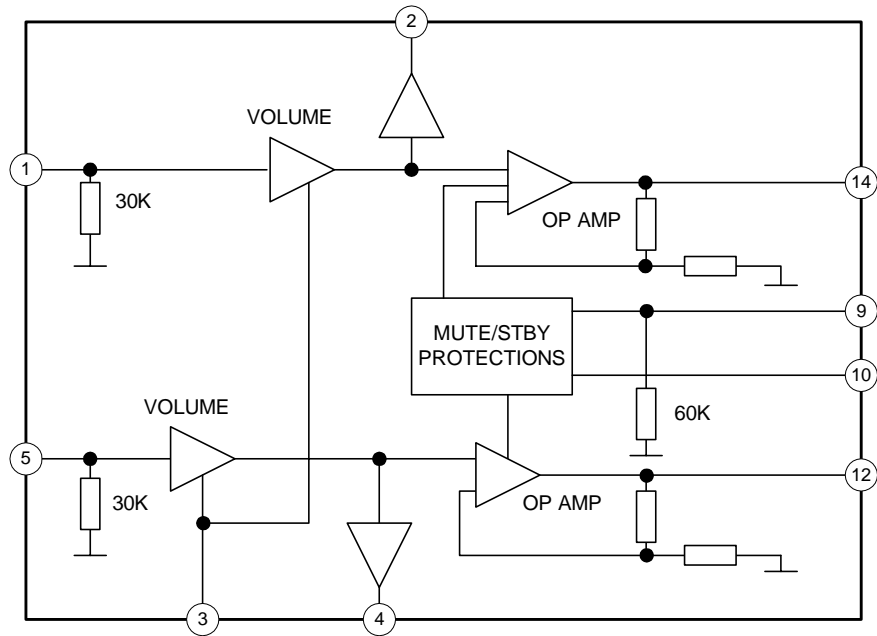

G BOARD IC6001 MCZ3001D

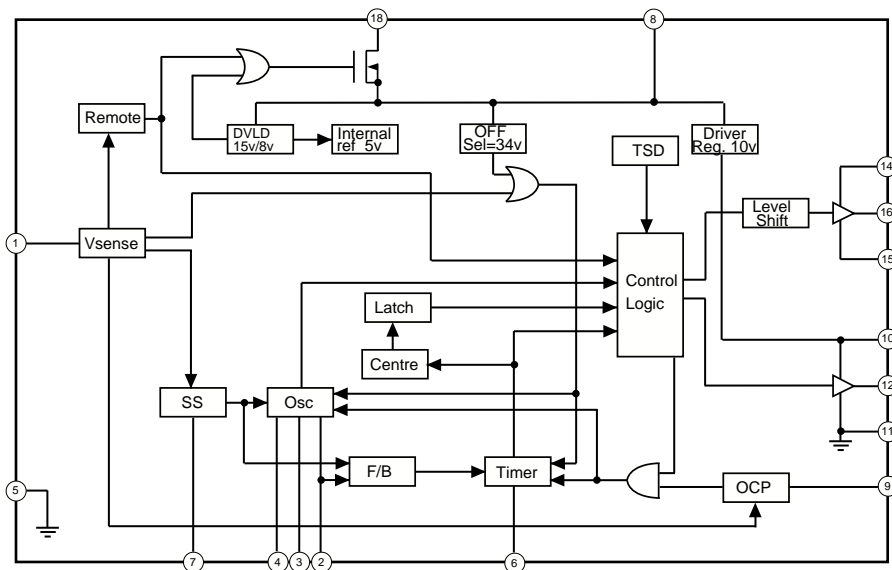

A BOARD IC2000 MSP3411G

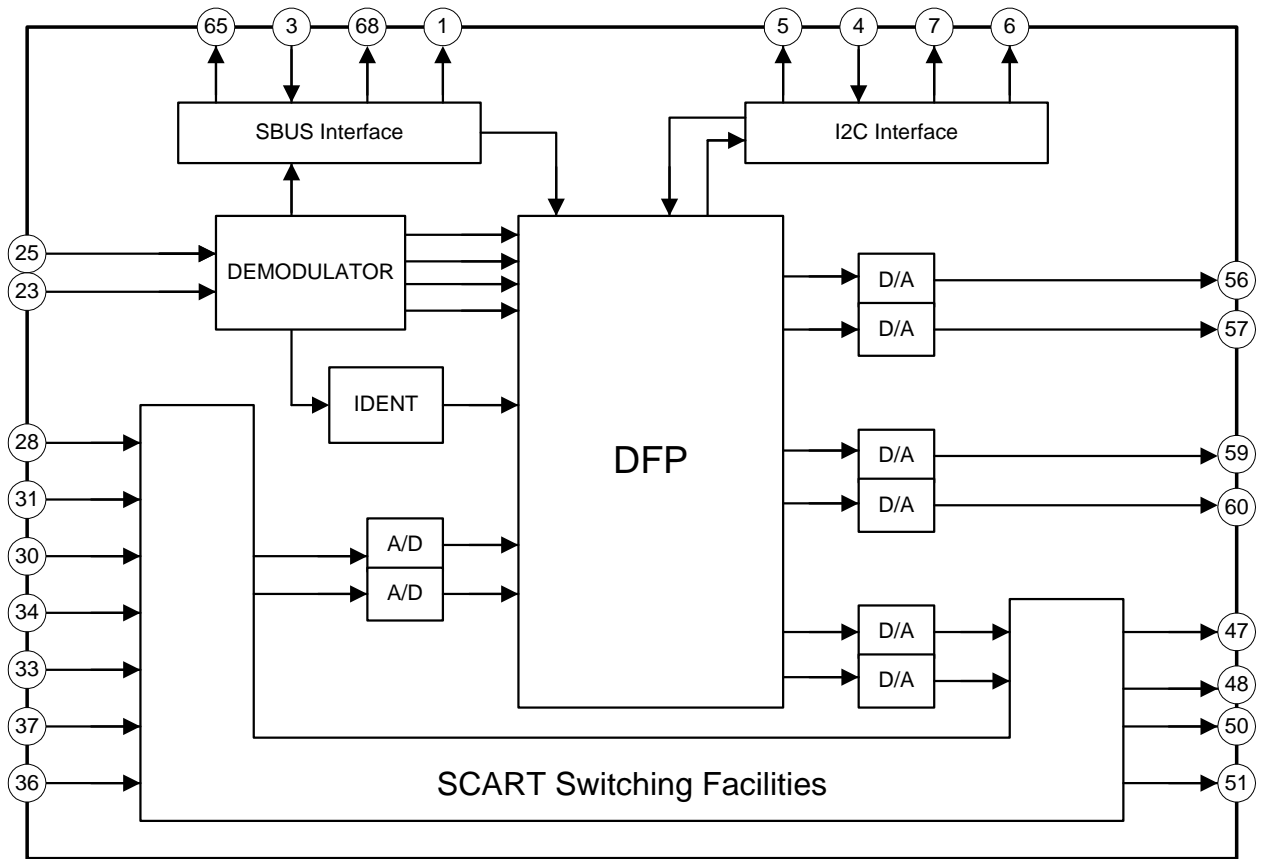

G BOARD IC6003 SE135N-LF4

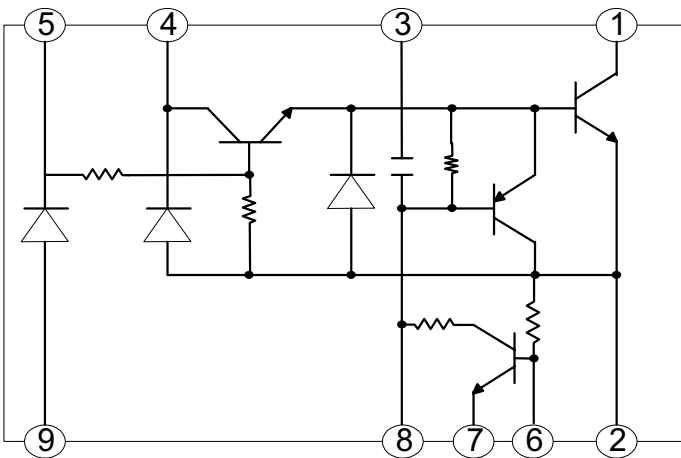

A BOARD IC5301/IC5302 LM393N

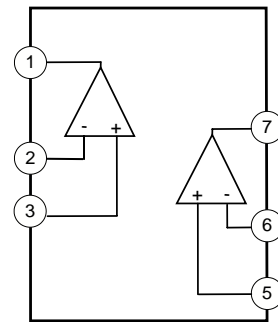

A BOARD IC5400 STV9379

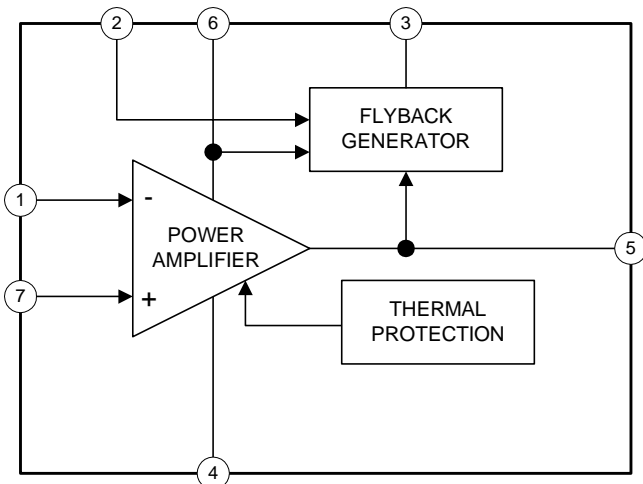

A BOARD IC5300 LM358N

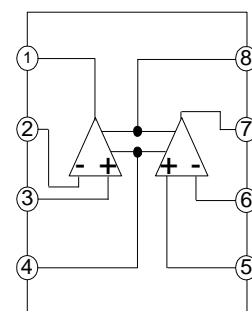

SECTION 6 EXPLODED VIEWS

Note : Les composants identifiés par une trame et par une marque △ sont d'une importance critique pour la sécurité. Ne les remplacer que par des pièces du numéro spécifié.

Note : The components identified by shading and marked △ are critical for safety. Replace only with the part numbers specified in the parts list.

NOTE :

- Items with no part number and no description are not stocked because they are seldom required for routine service.
- The construction parts of an assembled part are indicated with a collation number in the remarks column.
- Items marked “*” are not stocked since they are seldom required for routine service. Some delay should be anticipated when ordering these items.

6-1. CHASSIS

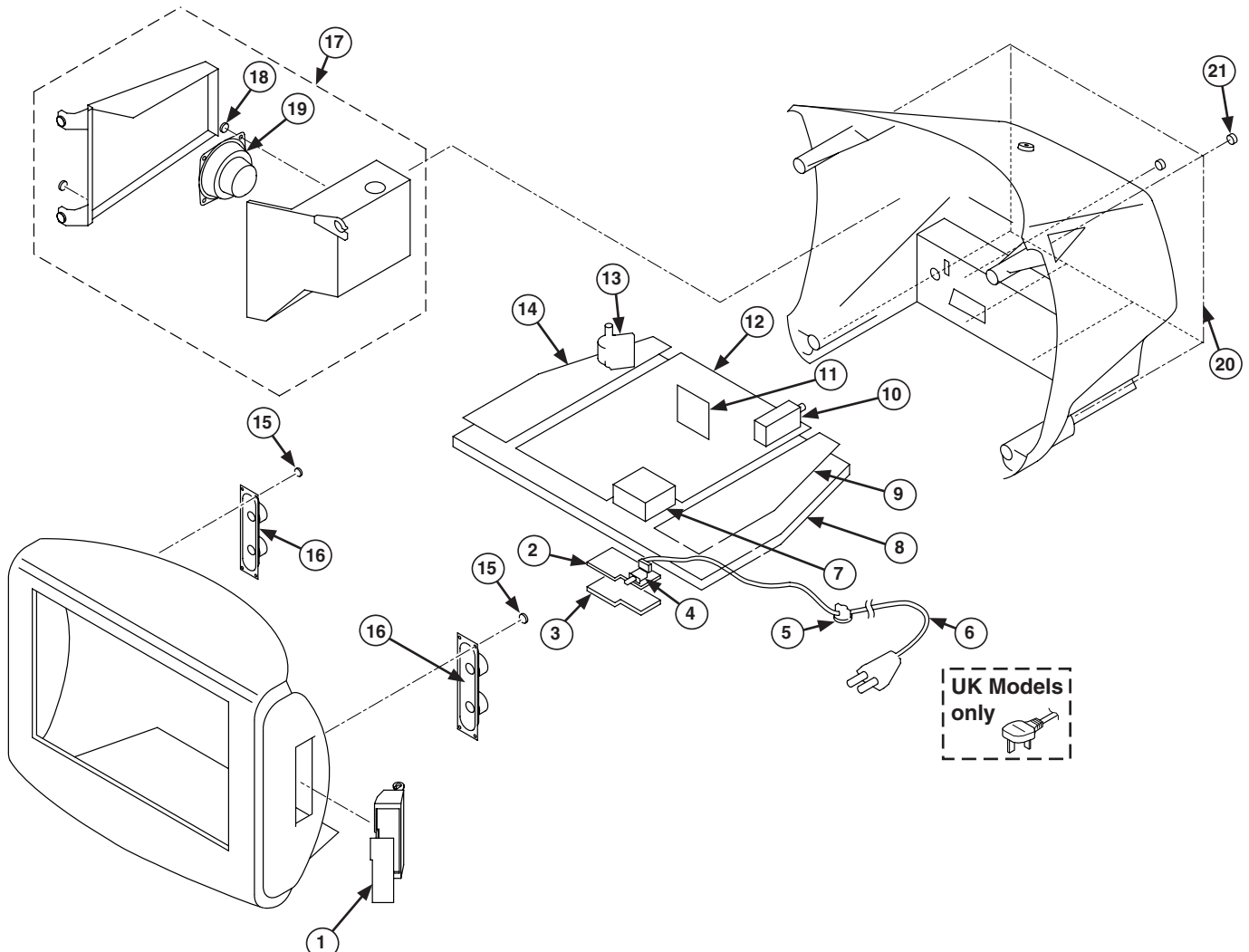

REF.NO.	PART.NO	DESCRIPTION	REMARK
1	*A-1647-043-A	H2 BOARD, COMPLETE	
2	*A-1624-102-A	F2 BOARD, COMPLETE	
3	*4-206-055-01	BRACKET F2	
4	△ 1-571-433-21	SWITCH, PUSH (AC POWER)	
5	*4-202-531-01	AC CORD LOCK (SC)	
6	△ 1-823-853-11	CORD, POWER (KV-28LS60B/28LS60E/32LS60B/ KV-32LS60E/32LS60K)	
	△ 1-776-860-12	POWER CORD, FILTER (UK) (KV-28LS60U/32LS60U)	
7	1-424-855-11	COIL, CHOKE 29MMH	
8	*4-206-106-01	BRACKET, MAIN	
9	*A-1300-179-A	G BOARD, COMPLETE	
10	8-598-535-11	FRONTEND BTF-EF411 (KV-28LS60B/32LS60B)	
	8-598-533-01	FRONTEND BTF-EC411 (KV-28LS60E/32LS60E /32LS60K)	
	8-598-529-01	FRONTEND BTF-EU611 (KV-28LS60U/32LS60U)	
11	*A-1300-287-A	M BOARD, COMPLETE	
12	*A-1300-302-A	A BOARD, COMPLETE (KV-28LS60B)	
	*A-1300-175-A	A BOARD, COMPLETE (KV-28LS60E)	

REF.NO.	PART.NO	DESCRIPTION	REMARK
	*A-1300-301-A	A BOARD, COMPLETE (KV-28LS60U)	
	*A-1300-288-A	A BOARD, COMPLETE (KV-32LS60B)	
	*A-1300-177-A	A BOARD, COMPLETE (KV-32LS60E/32LS60K)	
	*A-1300-289-A	A BOARD, COMPLETE (KV-32LS60U)	
13	△ 1-453-383-21	TRANSFORMER ASSY, FLYBACK (NX-4522//Z214) (KV-28LS60)	
	△ 1-453-340-31	TRANSFORMER ASSY, FLYBACK (NX-4522//Z2B4) (KV-32LS60)	
14	*A-1300-176-A	D BOARD, COMPLETE (KV-28LS60)	
	*A-1300-178-A	D BOARD, COMPLETE (KV-32LS60)	
15	7-685-663-71	SCREW +BVTP 4x16 TYPE 2 IT-3	
16	1-529-408-11	SPEAKER (4.2x24CM)	
17	*A-1678-219-A	WOOFER COMPL. ASSY	18-19
18	7-685-663-71	SCREW +BVTP 4x16 TYPE 2 IT-3	
19	1-529-989-11	SPEAKER (8CM)	
20	4-206-089-11	COVER REAR (KV-28LS60)	
	4-206-062-21	COVER REAR (KV-32LS60)	
21	7-685-663-79	SCREW +BVTP 4x16 TYPE 2 IT-3	

6-2. PICTURE TUBE

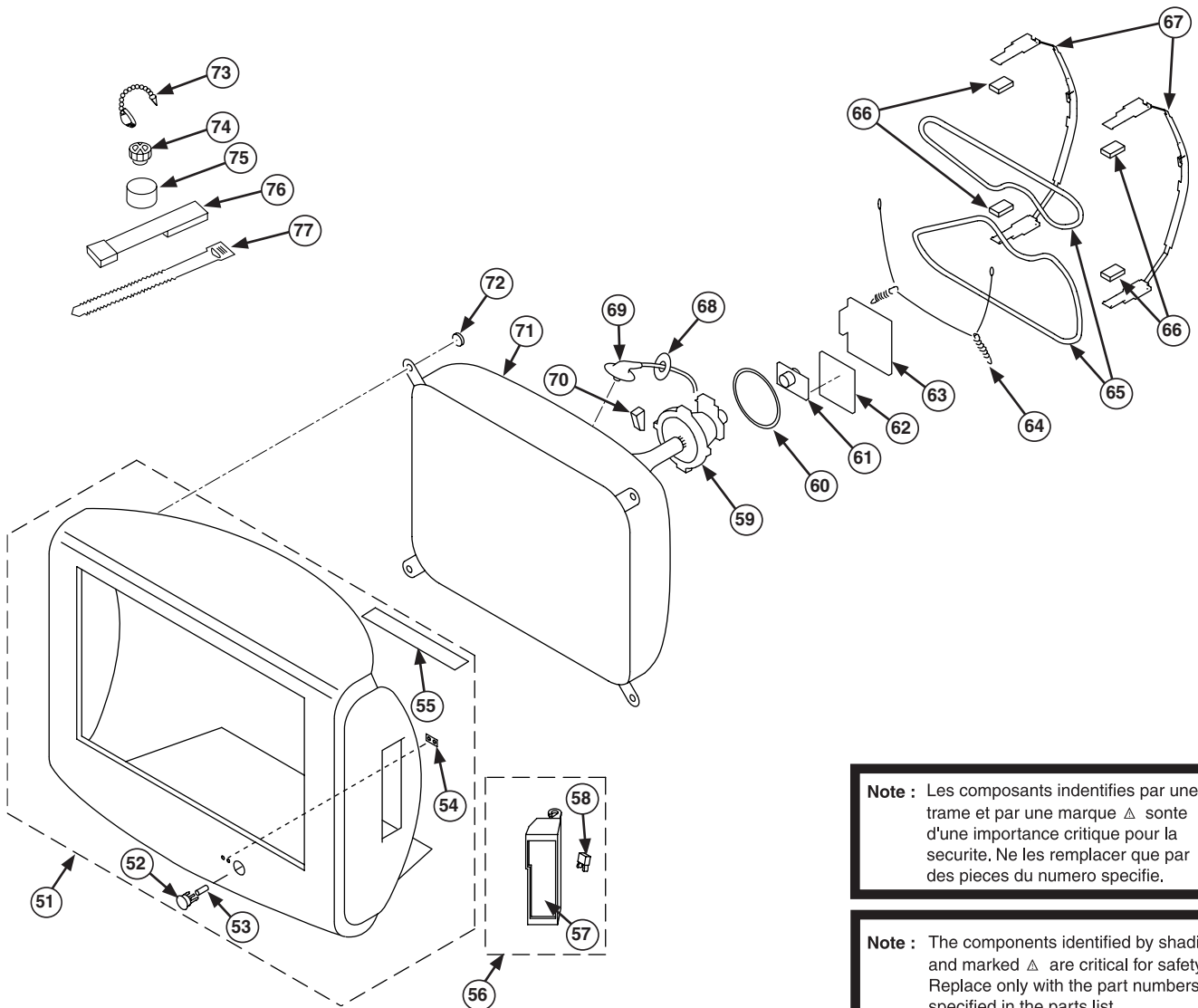

Note : Les composants identifiés par une trame et par une marque Δ sont d'une importance critique pour la sécurité. Ne les remplacer que par des pièces du numéro spécifié.

Note : The components identified by shading and marked Δ are critical for safety. Replace only with the part numbers specified in the parts list.

REF.NO.	PART.NO	DESCRIPTION	REMARK	REF.NO.	PART.NO	DESCRIPTION	REMARK
51	X-4039-915-1	BEZNET ASSY (KV-28LS60)	52-55	65	Δ 1-424-886-11	COIL, DEGAUSSING (KV-28LS60)	
	X-4200-824-1	BEZNET ASSY (KV-32LS60)			Δ 1-424-888-11	COIL, DEGAUSSING (KV-32LS60)	
52	4-205-948-02	POWER BUTTON		66	4-203-390-11	CUSHION, DGC	
53	4-204-426-01	SPRING		67	*4-204-768-01	HOLDER, DGC (29")	
54	4-205-375-01	GUIDE, LIGHT		68	*4-203-022-01	HOLDER, HV	
55	4-204-295-01	SHEET, BLOTTING		69	Δ 1-251-946-21	CAP ASSY, HIGH-VOLTAGE (KV-28LS60)	
56	X-4200-712-3	DOOR ASSY (KV-28LS60)	57-58		Δ 1-251-374-32	CAP ASSY, HIGH-VOLTAGE (KV-32LS60)	
	X-4039-993-1	DOOR ASSY (KV-32LS60)		70	3-704-495-01	SPACER, DY	
57	4-205-946-02	DOOR		71	Δ 8-735-099-05	PICTURE TUBE (W66LLX060X) (KV-28LS60)	
58	4-047-464-01	CATCHER, PUSH			Δ 8-735-079-05	PICTURE TUBE (W76LLZ060X) (KV-32LS60)	
59	Δ 8-451-521-11	DEFLECTION YOKE (Y28RVC3-B) (KV-28LS60)		72	4-046-765-12	SCREW, TAPPING 7+CROWN WASHER	
	Δ 1-451-480-11	DEFLECTION YOKE (Y32RVC2) (KV-32LS60)		73	4-308-870-00	CLIP, LEAD WIRE	
60	1-419-363-11	COIL, NA ROTATION (RT200)		74	1-452-094-00	MAGNET, ROTATABLE DISK; 15MM	
61	8-453-011-11	NECK ASSY, (NA299-M)		75	1-452-032-00	MAGNET, DISK; 10MM	
62	*A-1644-119-A	VM BOARD, COMPLETE		76	X-4387-214-1	PERMALLOY ASSY, CORRECTION	
63	*A-1638-158-A	C BOARD, COMPLETE		77	3-701-007-00	BAND, BINDING	
64	4-369-318-21	SPRING, TENSION					

SECTION 7 ELECTRICAL PARTS LIST

PARTS LISTING TABLE OF CONTENTS

	Page
D BOARD COMMON Parts List :	Parts common to all models listed in this manual 52
D BOARD VARIANT Parts List :	Parts that belong only to the model specified
Model	
<u>KV-28LS60</u> 55
<u>KV-32LS60</u> 55
G BOARD COMPLETE Parts List : 56
M BOARD COMPLETE Parts List : 57
A BOARD COMMON Parts List :	Parts common to all models listed in this manual 59
A BOARD VARIANT Parts List :	Parts that belong only to the model specified
Model	
<u>KV-28LS60B</u> 67
<u>KV-28LS60E</u> 68
<u>KV-28LS60U</u> 68
<u>KV-32LS60B</u> 68
<u>KV-32LS60E/32LS60K</u> 69
<u>KV-32LS60U</u> 69
F2 BOARD COMPLETE Parts List : 70
C BOARD COMPLETE Parts List : 70
H2 BOARD COMPLETE Parts List : 71
VM BOARD COMPLETE Parts List : 72
MISCELLANEOUS : 73
ACCESSORIES AND PACKAGING MATERIALS : 73
REMOTE COMMANDER : 73

Note : Refer to the designated variant parts list when seeking a part indicated by an asterisk (*)
Parts indicated (XX) on the Schematic Diagram are not used in this model and therefore do not appear in the Parts List.

REF.NO.	PART.NO	DESCRIPTION	REMARK	REF.NO.	PART.NO	DESCRIPTION	REMARK
*A-1300-176-A D Board, Complete (KV-28LS60)				C8818	1-125-893-11	FILM 680PF	3.00% 1.5KV
*A-1300-178-A D Board, Complete (KV-32LS60)				C8819	1-125-893-11	FILM 680PF	3.00% 1.5KV
D Board, Common Parts				C8820	1-125-893-11	FILM 680PF	3.00% 1.5KV
	4-382-854-01	SCREW (M3X8), P, SW (+)		C8824	1-107-846-11	FILM 0.1UF	5.00% 250V
	< CAPACITOR >			C8827	1-107-846-11	FILM 0.1UF	5.00% 250V
C8100	1-136-165-00	FILM 0.1UF	5.00% 50V	C8828	1-127-681-11	FILM 10000PF	2% 100V
C8101	1-136-165-00	FILM 0.1UF	5.00% 50V	C8829	1-127-680-11	FILM 4700PF	2% 100V
C8102	1-136-165-00	FILM 0.1UF	5.00% 50V	C8830	1-107-655-11	ELECT 47UF	20.00% 250V
C8103	1-115-416-11	CERAMIC CHIP 0.001UF	5.00% 25V	C8831	1-102-228-00	CERAMIC 470PF	10.00% 500V
C8104	1-115-416-11	CERAMIC CHIP 0.001UF	5.00% 25V	C8832	1-126-941-11	ELECT 470UF	20.00% 25V
C8105	1-126-947-11	ELECT 47UF	20.00% 25V	C8833	1-126-941-11	ELECT 470UF	20.00% 25V
C8106	1-164-315-91	CERAMIC CHIP 470PF	5.00% 50V	C8834	1-102-228-00	CERAMIC 470PF	10.00% 500V
C8108	1-162-970-11	CERAMIC CHIP 0.01UF	10.00% 25V	C8835	1-102-228-00	CERAMIC 470PF	10.00% 500V
C8109	1-126-947-11	ELECT 47UF	20.00% 25V	C8836	1-123-024-21	ELECT 33UF	160V
C8112	1-164-227-91	CERAMIC CHIP 22000PF	10.00% 25V	C8837	1-106-375-12	MYLAR 0.022UF	10.00% 250V
C8113	1-162-970-11	CERAMIC CHIP 0.01UF	10.00% 25V	C8840	1-165-176-11	CERAMIC CHIP 0.047UF	10.00% 16V
C8114	1-126-964-11	ELECT 10UF	20.00% 50V	C8841	1-126-947-11	ELECT 47UF	20.00% 25V
C8115	1-162-962-11	CERAMIC CHIP 470PF	10.00% 50V	C8844	1-115-513-21	FILM 0.18UF	5.00% 250V
C8116	1-115-416-11	CERAMIC CHIP 0.001UF	5.00% 25V	C8851	1-162-131-11	CERAMIC 220PF	10.00% 2KV
C8117	1-115-416-11	CERAMIC CHIP 0.001UF	5.00% 25V	C8852	1-162-129-00	CERAMIC 150PF	10.00% 2KV
C8118	1-162-970-11	CERAMIC CHIP 0.01UF	10.00% 25V	C8853	1-129-898-00	FILM 0.0022UF	5.00% 630V
C8120	1-165-176-11	CERAMIC CHIP 0.047UF	10.00% 16V	C8855	1-136-205-11	MYLAR 0.022UF	10.00% 400V
C8125	1-162-968-11	CERAMIC CHIP 0.0047UF	10.00% 50V	C8856	1-102-030-00	CERAMIC 330PF	10.00% 500V
C8126	1-165-176-11	CERAMIC CHIP 0.047UF	10.00% 16V	C8860	1-162-964-11	CERAMIC CHIP 0.001UF	10.00% 50V
C8128	1-162-968-11	CERAMIC CHIP 0.0047UF	10.00% 50V	C8861	1-162-927-11	CERAMIC CHIP 100PF	5.00% 50V
C8131	1-126-964-11	ELECT 10UF	20.00% 50V	C8869	1-162-964-11	CERAMIC CHIP 0.001UF	10.00% 50V
C8132	1-164-230-11	CERAMIC CHIP 220PF	5.00% 50V	< CONNECTOR >			
C8134	1-102-935-00	CERAMIC 2PF	0.25PF 50V	CN8600	*1-564-509-11	PLUG, CONNECTOR 6P	
C8135	1-126-964-11	ELECT 10UF	20.00% 50V	CN8601	*1-564-506-11	PLUG, CONNECTOR 3P	
C8136	1-126-964-11	ELECT 10UF	20.00% 50V	CN8611	*1-785-270-12	PIN, DY CONNECTOR (PC BOARD)	
C8140	1-164-004-11	CERAMIC CHIP 0.1UF	10.00% 25V	CN8612	*1-564-511-11	PLUG, CONNECTOR 8P	
C8141	1-136-165-00	FILM 0.1UF	5.00% 50V	CN8614	*1-564-508-11	PLUG, CONNECTOR 5P	
C8209	1-164-315-11	CERAMIC CHIP 470PF	5.00% 50V	CN8616	1-695-915-11	TAB (CONTACT)	
C8210	1-162-964-11	CERAMIC CHIP 0.001UF	10.00% 50V	CN8620	*1-764-333-11	PLUG, CONNECTOR 10P	
C8801	1-126-947-11	ELECT 47UF	20.00% 25V	CN8810	*1-564-510-11	PLUG, CONNECTOR 7P	
C8802	1-126-960-11	ELECT 1UF	20.00% 50V	< DIODE >			
C8803	1-126-960-11	ELECT 1UF	20.00% 50V	D8102	8-719-081-97	DIODE MMDL914T1	
C8804	1-102-114-00	CERAMIC 470PF	10.00% 50V	D8103	8-719-081-97	DIODE MMDL914T1	
C8805	1-102-114-00	CERAMIC 470PF	10.00% 50V	D8104	8-719-081-97	DIODE MMDL914T1	
C8808	1-102-030-00	CERAMIC 330PF	10.00% 500V	D8105	8-719-081-97	DIODE MMDL914T1	
C8809	1-102-030-00	CERAMIC 330PF	10.00% 500V	D8107	8-719-081-97	DIODE MMDL914T1	
C8810	1-107-368-11	MYLAR 0.047UF	10.00% 200V	D8108	8-719-921-40	DIODE MTZJ-4.7C	
C8811	1-107-368-11	MYLAR 0.047UF	10.00% 200V	D8128	8-719-081-97	DIODE MMDL914T1	
C8812	1-162-131-11	CERAMIC 220PF	10.00% 2KV	D8129	8-719-081-97	DIODE MMDL914T1	
C8813	1-162-134-11	CERAMIC 470PF	10.00% 2KV	D8132	8-719-081-97	DIODE MMDL914T1	
C8816	1-162-964-11	CERAMIC CHIP 0.001UF	10.00% 50V	D8133	8-719-081-97	DIODE MMDL914T1	
C8817	1-125-893-11	FILM 680PF	3.00% 1.5KV	D8198	1-535-143-61	LEAD, JUMPER (5.0MM)	

REF.NO.	PART.NO	DESCRIPTION	REMARK	REF.NO.	PART.NO	DESCRIPTION	REMARK
D8199	8-719-081-97	DIODE MMDL914T1		Q8112	8-729-010-29	TRANSISTOR MSD601-RST1	
D8611	8-719-081-97	DIODE MMDL914T1		Q8113	8-729-010-29	TRANSISTOR MSD601-RST1	
D8612	8-719-081-97	DIODE MMDL914T1		Q8115	8-729-010-05	TRANSISTOR MSB709-RT1	
D8803	8-719-908-03	DIODE GP08D		Q8118	8-729-010-29	TRANSISTOR MSD601-RST1	
D8805	8-719-302-43	DIODE EL1Z		Q8119	8-729-010-05	TRANSISTOR MSB709-RT1	
D8806	8-719-979-85	DIODE EPG20G		Q8120	8-729-010-05	TRANSISTOR MSB709-RT1	
D8807	8-719-510-73	DIODE S3L20UF4		Q8122	8-729-010-05	TRANSISTOR MSB709-RT1	
D8808	8-719-510-73	DIODE S3L20UF4		Q8123	8-729-010-05	TRANSISTOR MSB709-RT1	
D8811	8-719-110-41	DIODE RD15ES-B2		Q8125	8-729-010-29	TRANSISTOR MSD601-RST1	
D8818	8-719-109-89	DIODE RD15ES-B2		Q8126	8-729-010-05	TRANSISTOR MSB709-RT1	
D8819	8-719-050-38	DIODE M1MA152WK-T1		Q8127	8-729-010-05	TRANSISTOR MSB709-RT1	
D8820	8-719-081-97	DIODE MMDL914T1		Q8128	8-729-010-29	TRANSISTOR MSD601-RST1	
D8851	8-719-970-87	DIODE ERA38-06		Q8132	8-729-421-19	TRANSISTOR UN2213	
D8856	8-719-081-97	DIODE MMDL914T1		Q8135	8-729-010-29	TRANSISTOR MSD601-RST1	
D8857	8-719-110-41	DIODE RD15ES-B2		Q8136	8-729-010-05	TRANSISTOR MSB709-RT1	
D8858	8-719-081-97	DIODE MMDL914T1		Q8137	8-729-010-29	TRANSISTOR MSD601-RST1	
		< FERRITE BEAD >		Q8201	8-729-010-29	TRANSISTOR MSD601-RST1	
FB8806	1-410-397-21	FERRITE	1.1UH	Q8202	8-729-010-29	TRANSISTOR MSD601-RST1	
FB8807	1-410-397-21	FERRITE	1.1UH	Q8203	8-729-010-05	TRANSISTOR MSB709-RT1	
		< IC >		Q8455	8-729-010-29	TRANSISTOR MSD601-RST1	
IC8100	8-759-450-95	IC LM393N		Q8801	8-729-048-47	TRANSISTOR 2SC2688 (5)-LK	
IC8101	8-759-450-95	IC LM393N		Q8802	8-729-048-47	TRANSISTOR 2SC2688 (5)-LK	
IC8102	8-759-638-79	IC NJM3404AD-W		Q8803	8-729-056-16	TRANSISTOR 2SC5698-SONY-CA	
IC8103	8-759-450-95	IC LM393N		Q8804	8-729-056-17	TRANSISTOR 2SC5696-SONY-CA	
		< COIL >		Q8805	8-729-050-48	TRANSISTOR IRF614-005	
L8801	1-410-397-21	FERRITE	1.1UH	Q8806	8-729-047-59	TRANSISTOR STP5NB40FP	
L8802	1-410-397-21	FERRITE	1.1UH	Q8807	8-729-421-19	TRANSISTOR MUN2213T1	
L8803	1-410-397-21	FERRITE	1.1UH	Q8822	8-729-010-29	TRANSISTOR MSD601-RST1	
L8805	1-408-947-00	INDUCTOR	2.2MH	Q8823	8-729-424-08	TRANSISTOR UN2111	
L8851	1-535-143-61	LEAD, JUMPER (5.0MM)		Q8851	6-550-012-01	TRANSISTOR STP5NB40 (033Y)	
		< FILTER >				< RESISTOR >	
LF8801	1-406-985-11	INDUCTOR	2.2MH	R8100	1-216-813-11	RES-CHIP	220 5% 1/10W
LF8851	1-406-674-11	INDUCTOR	3.3MH	R8101	1-216-813-11	RES-CHIP	220 5% 1/10W
		< TRANSISTOR >		R8102	1-216-825-11	RES-CHIP	2.2K 5% 1/10W
Q8100	8-729-010-29	TRANSISTOR MSD601-RST1		R8103	1-216-825-11	RES-CHIP	2.2K 5% 1/10W
Q8101	8-729-010-29	TRANSISTOR MSD601-RST1		R8104	1-216-825-11	RES-CHIP	2.2K 5% 1/10W
Q8102	8-729-010-29	TRANSISTOR MSD601-RST1					
Q8103	8-729-010-29	TRANSISTOR MSD601-RST1		R8105	1-216-821-11	RES-CHIP	1K 5% 1/10W
Q8104	8-729-010-29	TRANSISTOR MSD601-RST1		R8106	1-216-825-11	RES-CHIP	2.2K 5% 1/10W
Q8105	8-729-010-29	TRANSISTOR MSD601-RST1		R8107	1-208-792-11	METAL CHIP	2.7K 0.5% 1/10W
Q8106	8-729-010-29	TRANSISTOR MSD601-RST1		R8108	1-208-792-11	METAL CHIP	2.7K 0.5% 1/10W
Q8107	8-729-010-29	TRANSISTOR MSD601-RST1		R8109	1-208-814-91	METAL CHIP	22K 0.5% 1/10W
Q8108	8-729-010-05	TRANSISTOR MSB709-RT1					
Q8110	8-729-010-05	TRANSISTOR MSB709-RT1		R8110	1-208-814-91	METAL CHIP	22K 0.5% 1/10W
				R8111	1-216-825-11	RES-CHIP	2.2K 5% 1/10W
				R8112	1-216-825-11	RES-CHIP	2.2K 5% 1/10W
				R8113	1-216-833-11	RES-CHIP	10K 5% 1/10W
				R8114	1-216-833-11	RES-CHIP	10K 5% 1/10W
				R8115	1-216-845-11	RES-CHIP	100K 5% 1/10W
				R8116	1-216-845-11	RES-CHIP	100K 5% 1/10W
				R8117	1-216-833-11	RES-CHIP	10K 5% 1/10W

REF.NO.	PART.NO	DESCRIPTION	REMARK	REF.NO.	PART.NO	DESCRIPTION	REMARK
R8118	1-216-833-11	RES-CHIP	10K 5% 1/10W	R8219	1-216-841-11	RES-CHIP	47K 5% 1/10W
R8119	1-216-833-11	RES-CHIP	10K 5% 1/10W	R8456	1-216-845-11	RES-CHIP	100K 5% 1/10W
R8120	1-216-825-11	RES-CHIP	2.2K 5% 1/10W	R8457	1-216-834-11	RES-CHIP	12K 5% 1/10W
R8121	1-216-825-11	RES-CHIP	2.2K 5% 1/10W	R8458	1-216-841-11	RES-CHIP	47K 5% 1/10W
R8122	1-216-825-11	RES-CHIP	2.2K 5% 1/10W	R8459	1-216-825-11	RES-CHIP	2.2K 5% 1/10W
R8123	1-216-841-11	RES-CHIP	47K 5% 1/10W	R8800	1-247-895-91	CARBON	470K 5% 1/4W
R8124	1-216-821-11	RES-CHIP	1K 5% 1/10W	R8804	1-249-408-11	CARBON	180 5% 1/4W
R8125	1-216-825-11	RES-CHIP	2.2K 5% 1/10W	R8805	1-249-408-11	CARBON	180 5% 1/4W
R8126	1-216-815-11	RES-CHIP	330 5% 1/10W	R8806	1-249-411-11	CARBON	330 5% 1/4W
R8128	1-208-822-11	METAL CHIP	47K 0.5% 1/10W	R8807	1-249-411-11	CARBON	330 5% 1/4W
R8129	1-208-822-11	METAL CHIP	47K 0.5% 1/10W	R8808	1-260-340-11	CARBON	10K 5% 1/2W
R8130	1-208-846-11	METAL CHIP	470K 0.5% 1/10W	R8809	1-260-340-11	CARBON	10K 5% 1/2W
R8131	1-216-815-11	RES-CHIP	330 5% 1/10W	R8811	1-215-896-00	METAL OXIDE	4.7K 5% 2W
R8132	1-216-815-11	RES-CHIP	330 5% 1/10W	R8812	1-215-896-00	METAL OXIDE	4.7K 5% 2W
R8133	1-216-815-11	RES-CHIP	330 5% 1/10W	R8813	1-215-895-11	METAL OXIDE	3.3K 5% 2W
R8136	1-208-822-11	METAL CHIP	47K 0.5% 1/10W	R8814	1-215-880-00	METAL OXIDE	10 5% 2W
R8137	1-208-822-11	METAL CHIP	47K 0.5% 1/10W	R8815	1-215-880-00	METAL OXIDE	10 5% 2W
R8138	1-208-822-11	METAL CHIP	47K 0.5% 1/10W	R8816	1-216-365-00	METAL OXIDE	0.47 5% 2W
R8139	1-208-822-11	METAL CHIP	47K 0.5% 1/10W	R8817	1-216-361-00	METAL OXIDE	0.22 5% 2W
R8140	1-216-825-11	RES-CHIP	2.2K 5% 1/10W	R8818	1-249-405-11	CARBON	100 5% 1/4W
R8143	1-216-825-11	RES-CHIP	2.2K 5% 1/10W	R8819	1-247-807-31	CARBON	100 5% 1/4W
R8145	1-216-825-11	RES-CHIP	2.2K 5% 1/10W	R8831	1-260-124-11	CARBON	120K 5% 1/2W
R8146	1-208-790-11	METAL CHIP	2.2K 0.5% 1/10W	R8833	1-202-972-61	FUSIBLE	1 5% 1/4W
R8153	1-216-295-91	SHORT	0	R8834	1-260-288-11	CARBON	0.47 5% 1/2W
R8160	1-216-295-91	SHORT	0	R8835	1-260-288-11	CARBON	0.47 5% 1/2W
R8162	1-216-821-11	RES-CHIP	1K 5% 1/10W	R8837	1-215-894-11	METAL OXIDE	2.2K 5% 2W
R8163	1-216-833-11	RES-CHIP	10K 5% 1/10W	R8838	1-214-905-11	METAL	47K 1% 1/2W
R8164	1-208-814-91	METAL CHIP	22K 0.5% 1/10W	R8839	1-215-894-11	METAL OXIDE	2.2K 5% 2W
R8165	1-208-830-11	METAL CHIP	100K 0.5% 1/10W	R8840	1-247-843-11	CARBON	3.3K 5% 1/4W
R8168	1-216-829-11	RES-CHIP	4.7K 5% 1/10W	R8842	1-260-123-11	CARBON	100K 5% 1/2W
R8169	1-208-830-11	METAL CHIP	100K 0.5% 1/10W	R8843	1-216-833-11	RES-CHIP	10K 5% 1/10W
R8170	1-216-815-11	RES-CHIP	330 5% 1/10W	R8844	1-216-838-11	RES-CHIP	27K 5% 1/10W
R8171	1-216-825-11	RES-CHIP	2.2K 5% 1/10W	R8845	1-216-833-11	RES-CHIP	10K 5% 1/10W
R8174	1-216-837-91	RES-CHIP	22K 5% 1/10W	R8851	1-260-123-11	CARBON	100K 5% 1/2W
R8180	1-216-825-11	RES-CHIP	2.2K 5% 1/10W	R8852	1-260-123-11	CARBON	100K 5% 1/2W
R8181	1-216-295-91	SHORT	0	R8853	1-260-123-11	CARBON	100K 5% 1/2W
R8182	1-216-841-11	RES-CHIP	47K 5% 1/10W	R8854	1-249-425-11	CARBON	4.7K 5% 1/4W
R8183	1-216-825-11	RES-CHIP	2.2K 5% 1/10W	R8865	1-216-829-11	RES-CHIP	4.7K 5% 1/10W
R8188	1-216-829-11	RES-CHIP	4.7K 5% 1/10W	R8866	1-216-295-91	SHORT	0
R8190	1-216-825-11	RES-CHIP	2.2K 5% 1/10W	R8867	1-216-829-11	RES-CHIP	4.7K 5% 1/10W
R8191	1-215-925-11	METAL OXIDE	22K 5% 3W	R8869	1-216-837-11	RES-CHIP	22K 5% 1/10W
R8196	1-249-377-11	CARBON	0.47 5% 1/4W	R8870	1-216-837-11	RES-CHIP	22K 5% 1/10W
R8197	1-216-841-11	RES-CHIP	47K 5% 1/10W	R8885	1-208-854-11	METAL CHIP	1M 0.5% 1/10W
R8204	1-216-295-91	SHORT	0	R8887	1-216-841-11	RES-CHIP	47K 5% 1/10W
R8205	1-216-295-91	SHORT	0	R8888	1-249-441-11	CARBON	100K 5% 1/4W
R8209	1-216-295-91	SHORT	0	R8895	1-249-443-11	CARBON	0.47 5% 1/4W
R8210	1-216-825-11	RES-CHIP	2.2K 5% 1/10W	R8896	1-249-443-11	CARBON	0.47 5% 1/4W
R8211	1-216-833-11	RES-CHIP	10K 5% 1/10W	R8898	1-215-493-00	METAL	1M 1% 1/4W
R8212	1-216-825-11	RES-CHIP	2.2K 5% 1/10W	R8899	1-215-493-00	METAL	1M 1% 1/4W
R8217	1-216-833-11	RES-CHIP	10K 5% 1/10W				

Note : The components identified by shading and marked Δ are critical for safety. Replace only with the part numbers specified in the parts list.

D

REF.NO.	PART.NO	DESCRIPTION	REMARK	REF.NO.	PART.NO	DESCRIPTION	REMARK
<TRANSFORMER >				R8886	1-218-760-11	METAL CHIP 220K 0.5%	1/10W
T8801	1-437-430-11	TRANSFORMER, FERRITE (HDT)		R8897	1-215-485-00	METAL 470K 1%	1/4W
T8802	1-437-430-11	TRANSFORMER, FERRITE (HDT)		<TRANSFORMER >			
T8852	1-437-690-11	TRANSFORMER, FERRITE (DFT)		T8800 Δ 1-453-383-21 TRANSFORMER ASSY, FLYBACK (NX4522//Z214)			

D Board Variant Parts KV-28LS60

< CAPACITOR >

C8107	NOT FITTED				
C8130	1-164-230-11	CERAMIC CHIP 220PF	5%	25V	
C8207	NOT FITTED				
C8208	NOT FITTED				
C8814	1-117-641-11	FILM 7500PF	3%	1.2KV	
C8815	1-117-836-11	FILM 6800PF	3%	1.5KV	
C8825	1-117-663-11	FILM 0.22UF	5%	250V	
C8826	1-115-520-11	FILM 0.68UF	5%	250V	

< RESISTOR >

R8127	1-208-798-11	METAL CHIP 4.7K	0.5%	1/10W	
R8141	1-208-814-91	METAL CHIP 22K	0.5%	1/10W	
R8142	1-208-803-11	METAL CHIP 7.5K	0.5%	1/10W	
R8144	1-216-849-11	RES-CHIP 220K	5%	1/10W	
R8149	1-216-837-91	RES-CHIP 22K	5%	1/10W	
R8150	1-216-831-11	RES-CHIP 22K	5%	1/10W	
R8154	1-216-830-91	RES-CHIP 5.6K	5%	1/10W	
R8155	1-208-798-11	METAL CHIP 4.7K	0.5%	1/10W	
R8158	1-208-790-11	METAL CHIP 2.2K	0.5%	1/10W	
R8159	1-208-790-11	METAL CHIP 2.2K	0.5%	1/10W	
R8161	1-208-802-11	METAL CHIP 6.8K	0.5%	1/10W	
R8175	1-216-829-11	RES-CHIP 4.7K	5%	1/10W	
R8176	1-216-864-91	SHORT	0		
R8177	1-216-830-11	RES-CHIP 5.6K	5%	1/10W	
R8179	1-216-829-11	RES-CHIP 4.7K	5%	1/10W	
R8186	1-216-826-11	RES-CHIP 2.7K	5%	1/10W	
R8189	1-216-823-91	RES-CHIP 1.5K	5%	1/10W	
R8203	1-216-831-91	RES-CHIP 6.8K	5%	1/10W	
R8206	1-216-853-91	RES-CHIP 470K	5%	1/10W	
R8207	1-216-850-91	RES-CHIP 270K	5%	1/10W	
R8215	1-208-814-91	METAL CHIP 22K	0.5%	1/10W	
R8216	1-216-841-91	RES-CHIP 47K	5%	1/10W	
R8220	1-216-831-91	RES-CHIP 6.8K	5%	1/10W	
R8221	1-216-836-91	RES-CHIP 18K	5%	1/10W	
R8224	NOT FITTED				
R8810	1-216-896-00	METAL OXIDE 4.7K	5%	2W	
R8836	1-249-432-11	CARBON 18K	5%	1/4W	
R8856	1-216-486-00	METAL OXIDE 8.2K	5%	3W	
R8857	1-216-486-00	METAL OXIDE 8.2K	5%	3W	
R8858	1-216-486-00	METAL OXIDE 8.2K	5%	3W	
R8859	1-216-486-00	METAL OXIDE 8.2K	5%	3W	

D Board Variant Parts KV-32LS60

< CAPACITOR >

C8107	1-208-816-91	RES-CHIP 27K	0.5%	1/10W	
C8130	NOT FITTED				
C8207	1-165-176-11	CERAMIC CHIP 0.047UF	10%	16V	
C8208	1-162-970-11	CERAMIC CHIP 0.01UF	10%	25V	
C8814	1-117-640-11	FILM 6800PF	3%	1.2KV	
C8815	1-117-835-11	FILM 6200PF	3%	1.5KV	
C8825	1-117-662-11	FILM 0.18UF	5%	250V	
C8826	1-115-519-11	FILM 0.56UF	5%	250V	

< RESISTOR >

R8127	1-208-802-11	METAL CHIP 6.8K	0.5%	1/10W	
R8141	1-208-818-11	METAL CHIP 33K	0.5%	1/10W	
R8142	1-208-798-11	METAL CHIP 4.7K	0.5%	1/10W	
R8144	1-216-846-11	RES-CHIP 120K	5%	1/10W	
R8149	1-216-828-11	RES-CHIP 3.9K	5%	1/10W	
R8150	1-218-867-11	RES-CHIP 6.8K	5%	1/10W	
R8154	1-216-827-11	RES-CHIP 3.3K	5%	1/10W	
R8155	1-216-059-00	RES-CHIP 2.7K	5%	1/10W	
R8158	1-208-798-11	METAL CHIP 4.7K	0.5%	1/10W	
R8159	1-216-295-91	SHORT	0		
R8161	1-208-804-11	METAL CHIP 8.2K	0.5%	1/10W	
R8175	1-218-867-11	RES-CHIP 6.8K	5%	1/10W	
R8176	1-216-833-11	RES-CHIP 10K	5%	1/10W	
R8177	1-216-829-11	RES-CHIP 4.7K	5%	1/10W	
R8179	1-216-295-91	SHORT	0		
R8186	1-216-828-91	RES-CHIP 3.9K	5%	1/10W	
R8189	1-216-818-91	RES-CHIP 560	5%	1/10W	
R8203	1-216-295-91	SHORT	0		
R8206	1-208-842-91	RES-CHIP 330K	0.5%	1/10W	
R8207	1-216-849-11	RES-CHIP 220K	5%	1/10W	
R8215	1-208-822-11	METAL CHIP 47K	0.5%	1/10W	
R8216	1-208-822-11	METAL CHIP 47K	0.5%	1/10W	
R8220	1-216-834-11	RES-CHIP 12K	5%	1/10W	
R8221	1-216-837-11	RES-CHIP 22K	5%	1/10W	
R8224	1-216-827-11	RES-CHIP 3.3K	5%	1/10W	
R8810	1-216-460-11	METAL OXIDE 3.9K	5%	2W	
R8836	1-249-431-11	CARBON 15K	5%	1/4W	
R8856	1-215-922-11	METAL OXIDE 6.8K	5%	3W	
R8857	1-215-922-11	METAL OXIDE 6.8K	5%	3W	
R8858	1-215-922-11	METAL OXIDE 6.8K	5%	3W	

Note : The components identified by shading and marked Δ are critical for safety. Replace only with the part numbers specified in the parts list.

D

G

REF.NO.	PART.NO	DESCRIPTION	REMARK	REF.NO.	PART.NO	DESCRIPTION	REMARK
R8859	1-215-922-11	METAL OXIDE	6.8K 5% 3W	C6103	1-126-971-11	ELECT	470UF 20.00% 50V
R8886	1-216-849-11	METAL CHIP	220K 5% 1/10W	C6105	1-126-964-11	ELECT	10UF 20.00% 50V
R8897	1-215-489-00	METAL	680K 1% 1/4W	C6106	1-126-964-11	ELECT	10UF 20.00% 50V
< TRANSFORMER >				< CONNECTOR >			
T8800	Δ 1-453-340-31	TRANSFORMER ASSY, FLYBACK (NX4522//Z2B4)		CN6001	Δ *1-691-291-11	PIN, CONNECTOR (PC BOARD)	5P
*A-1300-179-A G Board, Complete				CN6002	Δ *1-508-786-00	PIN, CONNECTOR (5MM PITCH)	2P
4-382-854-01		SCREW (M3X8), P, SW (+)		CN6003	Δ *1-508-765-00	PIN, CONNECTOR (5MM PITCH)	3P
< CAPACITOR >				CN6004	Δ *1-691-960-11	PIN, CONNECTOR (PC BOARD)	3P
C6001	Δ 1-137-999-11	FILM	0.1UF 275V	CN6005	*1-564-509-11	PLUG, CONNECTOR	6P
C6002	Δ 1-137-999-11	FILM	0.1UF 275V	CN6006	*1-564-516-11	PLUG, CONNECTOR	13P
C6003	Δ 1-119-889-51	CERAMIC	1000PF 20.00% 250V	CN6008	*1-564-507-11	PLUG, CONNECTOR	4P
C6004	Δ 1-119-889-51	CERAMIC	1000PF 20.00% 250V	< DIODE >			
C6005	1-126-965-91	ELECT	22UF 20.00% 50V	D6001	6-500-067-01	DIODE GSIB460L/45	
C6006	1-117-753-11	ELECT (BLOCK)	470UF 20.00% 450V	D6002	8-719-982-26	DIODE MTZJ-33B	
C6007	1-126-964-11	ELECT	10UF 20.00% 50V	D6004	8-719-979-64	DIODE UF4005PKG23	
C6008	1-126-963-11	ELECT	4.7UF 20.00% 50V	D6006	8-719-081-97	DIODE MMDL914T1	
C6010	1-136-165-00	FILM	0.1UF 5.00% 50V	D6007	8-719-081-97	DIODE MMDL914T1	
C6011	1-162-964-11	CERAMIC CHIP	0.001UF 10.00% 50V	D6008	8-719-063-70	DIODE D1NL20U	
C6012	Δ 1-161-830-00	CERAMIC	0.0047UF 500V	D6009	8-719-110-41	DIODE RD15ES-B2	
C6013	Δ 1-161-830-00	CERAMIC	0.0047UF 500V	D6010	8-719-085-24	DIODE FBIU4D7M1-B	
C6015	1-115-339-11	CERAMIC CHIP	0.1UF 10.00% 50V	D6016	8-719-312-47	DIODE RBA-406B	
C6016	1-161-830-00	CERAMIC	0.0047UF 500V	D6031	8-719-080-59	DIODE EK19-V0	
C6017	1-161-830-00	CERAMIC	0.0047UF 500V	D6032	8-719-080-59	DIODE EK19-V0	
C6018	1-126-949-11	ELECT	220UF 20.00% 35V	D6033	8-719-022-97	DIODE D2S4MF	
C6020	1-135-946-21	FILM	47000PF 3% 800V	D6034	8-719-022-97	DIODE D2S4MF	
C6021	1-164-645-11	CERAMIC	1000PF 10.00% 500V	D6101	8-719-081-97	DIODE MMDL914T1	
C6022	1-126-963-11	ELECT	4.7UF 20.00% 50V	D6102	8-719-511-40	DIODE S1VB40	
C6023	1-110-626-41	ELECT	330UF 20.00% 160V	D6103	8-719-081-97	DIODE MMDL914T1	
C6024	1-164-625-11	CERAMIC	680PF 10.00% 500V	D6104	8-719-081-97	DIODE MMDL914T1	
C6025	1-164-625-11	CERAMIC	680PF 10.00% 500V	D6105	8-719-081-97	DIODE MMDL914T1	
C6026	1-164-625-11	CERAMIC	680PF 10.00% 500V	D6106	8-719-081-97	DIODE MMDL914T1	
C6027	1-164-625-11	CERAMIC	680PF 10.00% 500V	D6107	8-719-081-97	DIODE MMDL914T1	
C6028	1-128-548-11	ELECT	4700UF 20.00% 25V	< FERRITE BEAD >			
C6029	1-126-939-11	ELECT	10000UF 20.00% 16V	FB6002	1-410-397-21	FERRITE	1.1UH
C6030	1-119-940-51	ELECT	4700UF 20.00% 50V	FB6003	1-410-397-21	FERRITE	1.1UH
C6032	Δ 1-127-802-51	CERAMIC	10000PF 20.00% 250V	FB6005	1-535-143-61	LEAD, JUMPER	(5.0MM)
C6033	1-162-964-11	CERAMIC CHIP	0.001UF 10.00% 50V	FB6006	1-535-143-61	LEAD, JUMPER	(5.0MM)
C6034	1-162-968-11	CERAMIC CHIP	0.0047UF 10.00% 50V	< IC >			
C6035	1-136-165-00	FILM	0.1UF 5.00% 50V	IC6001	8-759-670-30	IC MC23001D	
C6036	1-136-479-11	FILM	0.001UF 2.00% 50V	IC6003	8-749-016-19	IC SE135N-LF4	
C6037	1-126-947-11	ELECT	47UF 20.00% 25V	< COIL >			
C6038	1-164-645-11	CERAMIC	1000PF 10.00% 500V	L6001	1-406-663-21	INDUCTOR	47UH
C6039	1-125-891-11	CERAMIC CHIP	0.47UF 10.00% 10V	L6002	1-412-529-11	INDUCTOR	22UH
C6040	1-115-340-11	CERAMIC CHIP	0.22UF 10.00% 25V	L6003	1-412-529-11	INDUCTOR	22UH
C6045	1-115-339-11	CERAMIC CHIP	0.1UF 10.00% 50V	L6004	1-535-143-61	LEAD, JUMPER	(5.0MM)
C6102	1-126-943-11	ELECT	2200UF 20.00% 25V				

Note : The components identified by shading and marked Δ are critical for safety. Replace only with the part numbers specified in the parts list.

G M

REF.NO.	PART.NO	DESCRIPTION	REMARK	REF.NO.	PART.NO	DESCRIPTION	REMARK
L6005	1-535-143-61	LEAD, JUMPER (5.0MM)		R6038	1-208-830-11	METAL CHIP 100K 0.5%	1/10W
L6006	1-406-659-11	INDUCTOR 10UH		R6039	1-208-830-11	METAL CHIP 100K 0.5%	1/10W
L6007	1-412-525-31	INDUCTOR 10UH		R6040	1-208-814-91	METAL CHIP 22K 0.5%	1/10W
		< PHOTO COUPLER >		R6042	1-216-295-91	SHORT	0
PH6001	Δ 8-749-016-21	IC TCET1103G		R6045	1-208-770-11	METAL CHIP 330 0.5%	1/10W
		< TRANSISTOR >		R6047	1-208-842-11	METAL CHIP 330K 0.5%	1/10W
Q6003	8-729-010-29	TRANSISTOR MSD601-RST1		R6048	1-215-481-00	METAL 330K 1%	1/4W
Q6005	8-729-029-56	TRANSISTOR DTA144ESA		R6049	1-208-805-11	METAL CHIP 9.1K 0.5%	1/10W
Q6006	6-550-146-01	TRANSISTOR SPA07N60C2-E8152		R6050	1-208-758-11	METAL CHIP 100 0.5%	1/10W
Q6007	6-550-146-01	TRANSISTOR SPA07N60C2-E8152		R6054	1-216-615-11	METAL CHIP 33 0.5%	1/10W
Q6010	8-729-119-78	TRANSISTOR 2SC2785-HFE		R6056	1-216-295-91	SHORT	0
Q6101	8-729-029-56	TRANSISTOR DTA144ESA		R6101	1-216-821-11	RES-CHIP 1K 5%	1/10W
Q6102	8-729-010-29	TRANSISTOR MSD601-RST1		R6102	1-216-829-11	RES-CHIP 4.7K 5%	1/10W
Q6103	8-729-029-56	TRANSISTOR DTA144ESA		R6103	1-216-821-11	RES-CHIP 1K 5%	1/10W
Q6104	8-729-010-29	TRANSISTOR MSD601-RST1		R6104	1-216-821-11	RES-CHIP 1K 5%	1/10W
Q6105	8-729-010-29	TRANSISTOR MSD601-RST1		R6105	1-216-821-11	RES-CHIP 1K 5%	1/10W
		< RESISTOR >		R6106	1-216-829-11	RES-CHIP 4.7K 5%	1/10W
JR6001	1-216-295-91	SHORT	0	R6107	1-216-829-11	RES-CHIP 4.7K 5%	1/10W
JR6004	1-216-295-91	SHORT	0	R6108	1-216-821-11	RES-CHIP 1K 5%	1/10W
R6003	1-202-933-61	FUSIBLE 0.1 10%	1/2W	R6109	1-216-829-11	RES-CHIP 4.7K 5%	1/10W
R6004	Δ 1-205-998-11	CEMENTED 1 5%	10W	R6110	1-216-821-11	RES-CHIP 1K 5%	1/10W
R6005	Δ 1-205-998-11	CEMENTED 1 5%	10W			< RELAY >	
R6006	Δ 1-205-998-11	CEMENTED 1 5%	10W	RY6001	Δ 1-755-395-11	RELAY (AC POWER)	
R6007	1-243-979-21	METAL OXIDE 0.1 5%	2W	RY6002	Δ 1-755-389-11	RELAY (AC POWER)	
R6008	1-243-979-21	METAL OXIDE 0.1 5%	2W			< TRANSFORMER >	
R6009	1-208-810-11	METAL CHIP 15K 0.5%	1/10W	T6002	Δ 1-437-443-11	TRANSFORMER, CONVERTER (PIT)	
R6010	1-215-481-00	METAL 330K 1%	1/4W	T6003	Δ 1-424-896-11	TRANSFORMER, LINE FILTER	
R6013	Δ 1-218-265-11	METAL 8.2M 5%	1W	T6101	Δ 1-437-483-11	TRANSFORMER, STANDBY	
R6014	1-215-926-00	METAL OXIDE 33K 5%	3W			< THERMISTOR >	
R6015	1-208-757-11	METAL CHIP 91 0.5%	1/10W	TH6002	Δ 1-804-650-11	THERMISTOR	
R6016	1-216-821-11	RES-CHIP 1K 5%	1/10W			*A-1300-287-A M Board, Complete	
R6017	1-216-833-11	RES-CHIP 10K 5%	1/10W			< CAPACITOR >	
R6018	1-260-131-11	CARBON 470K 5%	1/2W	C0001	1-107-826-11	CERAMIC CHIP 0.1UF	10.00% 16V
R6019	1-260-129-11	CARBON 330K 5%	1/2W	C0002	1-109-982-11	CERAMIC CHIP 1UF	10.00% 10V
R6020	1-216-820-11	RES-CHIP 820 5%	1/10W	C0004	1-165-128-11	CERAMIC CHIP 0.22UF	16V
R6021	1-216-362-11	METAL OXIDE 0.27 5%	2W	C0006	1-126-947-11	ELECT 47UF	20.00% 25V
R6022	1-216-833-11	RES-CHIP 10K 5%	1/10W	C0007	1-107-826-11	CERAMIC CHIP 0.1UF	10.00% 16V
R6024	1-216-615-11	METAL CHIP 33 0.5%	1/10W	C0008	1-107-826-11	CERAMIC CHIP 0.1UF	10.00% 16V
R6029	1-216-833-11	RES-CHIP 10K 5%	1/10W	C0009	1-165-128-11	CERAMIC CHIP 0.22UF	16V
R6030	1-216-817-11	RES-CHIP 470 5%	1/10W	C0010	1-162-927-11	CERAMIC CHIP 100PF	5.00% 50V
R6032	1-249-417-11	CARBON 1K 5%	1/4W	C0011	1-165-128-11	CERAMIC CHIP 0.22UF	16V
R6033	1-215-481-00	METAL 330K 1%	1/4W	C0012	1-162-924-11	CERAMIC CHIP 56PF	5.00% 50V
R6034	1-249-389-11	CARBON 4.7 5%	1/4W	C0013	1-165-128-11	CERAMIC CHIP 0.22UF	16V
R6035	1-260-083-11	CARBON 47 5%	1/2W	C0015	1-135-834-91	CERAMIC CHIP 2.2E+06PF	6.3V
R6036	1-216-817-11	RES-CHIP 470 5%	1/10W				
R6037	1-249-405-11	CARBON 100 5%	1/4W				

REF.NO.	PART.NO	DESCRIPTION	REMARK	REF.NO.	PART.NO	DESCRIPTION	REMARK
C0016	1-165-128-11	CERAMIC CHIP 0.22UF	16V	Q0011	8-729-010-29	TRANSISTOR MSD601-RST1	
C0017	1-162-924-11	CERAMIC CHIP 56PF	5.00% 50V	Q0012	8-729-424-08	TRANSISTOR UN2111	
C0019	1-165-128-11	CERAMIC CHIP 0.22UF	16V	Q0013	8-729-421-22	TRANSISTOR UN2211	
C0020	1-162-923-11	CERAMIC CHIP 47PF	5.00% 50V	< RESISTOR >			
C0025	1-162-962-11	CERAMIC CHIP 470PF	10.00% 50V	R0001	1-216-045-00	RES-CHIP 680 5%	1/10W
C0026	1-162-962-11	CERAMIC CHIP 470PF	10.00% 50V	R0002	1-216-055-00	RES-CHIP 1.8K 5%	1/10W
C0027	1-162-962-11	CERAMIC CHIP 470PF	10.00% 50V	R0003	1-216-025-11	RES-CHIP 100 5%	1/10W
C0028	1-126-947-11	ELECT 47UF	20.00% 25V	R0011	1-216-025-11	RES-CHIP 100 5%	1/10W
< CONNECTOR >				R0014	1-216-081-00	RES-CHIP 22K 5%	1/10W
CN0001	1-793-497-11	CONNECTOR, BOARD TO BOARD 40P		R0016	1-216-025-11	RES-CHIP 100 5%	1/10W
< DIODE >				R0017	1-216-093-91	RES-CHIP 68K 5%	1/10W
D0001	8-719-992-02	DIODE RB705D		R0018	1-216-025-11	RES-CHIP 100 5%	1/10W
D0301	8-719-069-56	DIODE UDZSTE-176.2B		R0019	1-216-025-11	RES-CHIP 100 5%	1/10W
< FERRITE BEAD >				R0020	1-216-049-11	RES-CHIP 1K 5%	1/10W
FB0003	1-216-295-91	SHORT 0		R0022	1-216-809-11	RES-CHIP 100 5%	1/10W
FB0004	1-412-006-31	INDUCTOR 10UH		R0023	1-216-097-11	RES-CHIP 100K 5%	1/10W
FB0005	1-216-864-11	SHORT 0		R0027	1-216-821-11	RES-CHIP 1K 5%	1/10W
FB0006	1-216-864-11	SHORT 0		R0028	1-216-833-11	RES-CHIP 10K 5%	1/10W
FB0007	1-216-295-91	SHORT 0		R0029	1-216-025-11	RES-CHIP 100 5%	1/10W
FB0008	1-216-295-91	SHORT 0		R0030	1-216-025-11	RES-CHIP 100 5%	1/10W
FB0009	1-412-006-31	INDUCTOR 10UH		R0032	1-216-809-11	RES-CHIP 100 5%	1/10W
FB0010	1-216-295-91	SHORT 0		R0033	1-216-809-11	RES-CHIP 100 5%	1/10W
FB0011	1-412-006-31	INDUCTOR 10UH		R0034	1-218-725-11	RES-CHIP 24K 5%	1/10W
FB0012	1-216-295-91	SHORT 0		R0035	1-216-069-00	RES-CHIP 6.8K 5%	1/10W
FB0015	1-216-864-11	SHORT 0		R0037	1-216-061-91	RES-CHIP 3.3K 5%	1/10W
FB0016	1-216-864-11	SHORT 0		R0039	1-216-809-11	RES-CHIP 100 5%	1/10W
FB0017	1-216-295-91	SHORT 0		R0040	1-216-809-11	RES-CHIP 100 5%	1/10W
FB0018	1-216-295-91	SHORT 0		R0041	1-216-057-00	RES-CHIP 2.2K 5%	1/10W
FB0019	1-216-295-91	SHORT 0		R0042	1-216-069-00	RES-CHIP 6.8K 5%	1/10W
FB0020	1-216-295-91	SHORT 0		R0043	1-216-803-11	RES-CHIP 33 5%	1/10W
< IC >				R0044	1-216-025-11	RES-CHIP 100 5%	1/10W
IC0001	8-759-699-33	IC M24C16-MN6T(A)		R0045	1-216-803-11	RES-CHIP 33 5%	1/10W
IC0002	6-702-143-01	IC SAA5667HL/M1/0560		R0046	1-216-803-11	RES-CHIP 33 5%	1/10W
IC0003	8-759-672-39	IC PST573IMT		R0047	1-216-810-11	RES-CHIP 120 5%	1/10W
IC0004	8-759-665-11	IC LM393DT		R0048	1-216-809-11	RES-CHIP 100 5%	1/10W
IC0005	6-700-132-01	IC K6T2008V2A-YF70T00		R0049	1-216-073-91	RES-CHIP 10K 5%	1/10W
< TRANSISTOR >				R0050	1-216-810-11	RES-CHIP 120 5%	1/10W
Q0002	8-729-424-08	TRANSISTOR UN2111		R0051	1-216-835-11	RES-CHIP 15K 5%	1/10W
Q0003	8-729-424-08	TRANSISTOR UN2111		R0052	1-216-810-11	RES-CHIP 120 5%	1/10W
Q0006	8-729-010-29	TRANSISTOR MSD601-RST1		R0053	1-216-809-11	RES-CHIP 100 5%	1/10W
Q0007	8-729-027-44	TRANSISTOR DTC114TKA-T146		R0054	1-216-809-11	RES-CHIP 100 5%	1/10W
Q0008	8-729-027-44	TRANSISTOR DTC114TKA-T146		R0055	1-216-809-11	RES-CHIP 100 5%	1/10W
Q0009	8-729-027-44	TRANSISTOR DTC114TKA-T146		R0056	1-216-833-11	RES-CHIP 10K 5%	1/10W
Q0010	8-729-027-44	TRANSISTOR DTC114TKA-T146		R0057	1-216-809-11	RES-CHIP 100 5%	1/10W
				R0058	1-216-823-11	RES-CHIP 1.5K 5%	1/10W
				R0059	1-216-841-11	RES-CHIP 47K 5%	1/10W
				R0060	1-216-833-11	RES-CHIP 10K 5%	1/10W
				R0061	1-216-833-11	RES-CHIP 10K 5%	1/10W
				R0062	1-216-833-11	RES-CHIP 10K 5%	1/10W

REF.NO.	PART.NO	DESCRIPTION	REMARK	REF.NO.	PART.NO	DESCRIPTION	REMARK
R0063	1-216-073-91	RES-CHIP	10K 5% 1/10W	C2007	1-163-021-91	CERAMIC CHIP	0.01UF 10.00% 50V
R0065	1-216-073-91	RES-CHIP	10K 5% 1/10W	C2008	1-162-964-11	CERAMIC CHIP	0.001UF 10.00% 50V
R0066	1-218-871-11	METAL CHIP	10K 0.5% 1/10W	C2009	1-163-021-91	CERAMIC CHIP	0.01UF 10.00% 50V
R0067	1-216-833-11	RES-CHIP	10K 5% 1/10W	C2010	1-162-964-11	CERAMIC CHIP	0.001UF 10.00% 50V
R0068	1-216-833-11	RES-CHIP	10K 5% 1/10W	C2011	1-162-962-11	CERAMIC CHIP	470PF 10.00% 50V
R0069	1-216-073-91	RES-CHIP	10K 5% 1/10W	C2012	1-162-962-11	CERAMIC CHIP	470PF 10.00% 50V
R0070	1-216-025-11	RES-CHIP	100 5% 1/10W	C2013	1-162-962-11	CERAMIC CHIP	470PF 10.00% 50V
R0071	1-216-809-11	RES-CHIP	100 5% 1/10W	C2014	1-164-346-11	CERAMIC CHIP	1UF 16V
R0072	1-216-809-11	RES-CHIP	100 5% 1/10W	C2015	1-163-021-91	CERAMIC CHIP	0.01UF 10.00% 50V
R0073	1-216-809-11	RES-CHIP	100 5% 1/10W	C2016	1-162-962-11	CERAMIC CHIP	470PF 10.00% 50V
R0074	1-216-809-11	RES-CHIP	100 5% 1/10W	C2018	1-162-962-11	CERAMIC CHIP	470PF 10.00% 50V
R0075	1-216-025-11	RES-CHIP	100 5% 1/10W	C2019	1-164-346-11	CERAMIC CHIP	1UF 16V
R0076	1-216-049-11	RES-CHIP	1K 5% 1/10W	C2021	1-162-962-11	CERAMIC CHIP	470PF 10.00% 50V
R0078	1-216-041-00	RES-CHIP	470 5% 1/10W	C2022	1-162-966-11	CERAMIC CHIP	0.0022UF 10.00% 50V
R0079	1-216-065-91	RES-CHIP	4.7K 5% 1/10W	C2023	1-162-966-11	CERAMIC CHIP	0.0022UF 10.00% 50V
R0301	1-216-073-91	RES-CHIP	10K 5% 1/10W	C2024	1-164-346-11	CERAMIC CHIP	1UF 16V
R0302	1-216-073-91	RES-CHIP	10K 5% 1/10W	C2026	1-162-962-11	CERAMIC CHIP	470PF 10.00% 50V
R0303	1-216-836-11	RES-CHIP	18K 5% 1/10W	C2027	1-126-947-11	ELECT	47UF 20.00% 25V
R0304	1-218-867-11	RES-CHIP	6.8K 5% 1/10W	C2028	1-126-947-11	ELECT	47UF 20.00% 25V
< CRYSTAL >				C2029	1-164-346-11	CERAMIC CHIP	1UF 16V
X0001	1-578-774-71	VIBRATOR, CRYSTAL		C2031	1-162-962-11	CERAMIC CHIP	470PF 10.00% 50V
*A-1300-302-A A Board, Complete (KV-28LS60B) *A-1300-301-A A Board, Complete (KV-28LS60U) *A-1300-175-A A Board, Complete (KV-28LS60E) *A-1300-288-A A Board, Complete (KV-32LS60B) *A-1300-289-A A Board, Complete (KV-32LS60U) *A-1300-177-A A Board, Complete (KV-32LS60E/ KV-32LS60K)				C2034	1-164-346-11	CERAMIC CHIP	1UF 16V
A Board, Common Parts				C2035	1-164-346-11	CERAMIC CHIP	1UF 16V
	4-382-854-01	SCREW (M3X8), P, SW (+)		C2038	1-162-970-11	CERAMIC CHIP	0.01UF 10.00% 25V
< CAPACITOR >				C2039	1-162-906-11	CERAMIC CHIP	1.5PF 0.25PF 50V
C1001	1-126-933-11	ELECT	100UF 20.00% 16V	C2040	1-162-964-11	CERAMIC CHIP	0.001UF 10.00% 50V
C1002	1-126-964-11	ELECT	10UF 20.00% 50V	C2041	1-162-906-11	CERAMIC CHIP	1.5PF 0.25PF 50V
C1004	1-163-021-91	CERAMIC CHIP	0.01UF 10.00% 50V	C2042	1-216-864-11	SHORT	0
C1006	1-126-933-11	ELECT	100UF 20.00% 16V	C2043	1-162-962-11	CERAMIC CHIP	470PF 10.00% 50V
C1008	1-163-021-91	CERAMIC CHIP	0.01UF 10.00% 50V	C2044	1-163-021-91	CERAMIC CHIP	0.01UF 10.00% 50V
C1009	1-162-925-11	CERAMIC CHIP	68PF 5.00% 50V	C2046	1-162-923-11	CERAMIC CHIP	47PF 5.00% 50V
C1010	1-162-925-11	CERAMIC CHIP	68PF 5.00% 50V	C2047	1-162-927-11	CERAMIC CHIP	100PF 5.00% 50V
C1014	1-126-933-11	ELECT	100UF 20.00% 16V	C2048	1-126-947-11	ELECT	47UF 20.00% 25V
C1015	1-163-021-91	CERAMIC CHIP	0.01UF 10.00% 50V	C2049	1-162-925-11	CERAMIC CHIP	68PF 5.00% 50V
C1018	1-115-340-11	CERAMIC CHIP	0.22UF 10.00% 25V	C2050	1-107-823-11	CERAMIC CHIP	0.47UF 10.00% 16V
C1020	1-164-004-11	CERAMIC CHIP	0.1UF 10.00% 25V	C2051	1-126-964-11	ELECT	10UF 20.00% 50V
C1021	1-162-968-11	CERAMIC CHIP	0.0047UF 10.00% 50V	C2052	1-164-004-11	CERAMIC CHIP	0.1UF 10.00% 25V
C1022	1-216-295-91	SHORT	0	C2053	1-164-227-11	CERAMIC CHIP	0.022UF 10.00% 25V
C2000	1-162-968-11	CERAMIC CHIP	0.0047UF 10.00% 50V	C2054	1-126-947-11	ELECT	47UF 20.00% 25V
C2001	1-162-968-11	CERAMIC CHIP	0.0047UF 10.00% 50V	C2055	1-162-968-11	CERAMIC CHIP	0.0047UF 10.00% 50V
C2006	1-162-962-11	CERAMIC CHIP	470PF 10.00% 50V	C2057	1-126-964-11	ELECT	10UF 20.00% 50V
				C2058	1-164-004-11	CERAMIC CHIP	0.1UF 10.00% 25V
				C2059	1-126-964-11	ELECT	10UF 20.00% 50V
				C2060	1-126-947-11	ELECT	47UF 20.00% 25V
				C2061	1-162-968-11	CERAMIC CHIP	0.0047UF 10.00% 50V
				C2062	1-164-346-11	CERAMIC CHIP	1UF 16V
				C2063	1-164-346-11	CERAMIC CHIP	1UF 16V
				C2064	1-126-964-11	ELECT	10UF 20.00% 50V
				C2065	1-162-966-11	CERAMIC CHIP	0.0022UF 10.00% 50V
				C2066	1-162-966-11	CERAMIC CHIP	0.0022UF 10.00% 50V

REF.NO.	PART.NO	DESCRIPTION	REMARK	REF.NO.	PART.NO	DESCRIPTION	REMARK
C2069	1-127-715-91	CERAMIC CHIP 0.22UF	10% 16V	C3211	1-126-964-11	ELECT 10UF	20.00% 50V
C2073	1-126-960-11	ELECT 1UF	20.00% 50V	C3213	1-164-222-91	CERAMIC CHIP 0.22UF	25V
C2074	1-126-960-11	ELECT 1UF	20.00% 50V	C3214	1-164-222-91	CERAMIC CHIP 0.22UF	25V
C2075	1-126-960-11	ELECT 1UF	20.00% 50V	C3215	1-164-222-91	CERAMIC CHIP 0.22UF	25V
C2077	1-126-960-11	ELECT 1UF	20.00% 50V	C3216	1-164-222-91	CERAMIC CHIP 0.22UF	25V
C2078	1-126-963-11	ELECT 4.7UF	20.00% 50V	C3217	1-164-222-91	CERAMIC CHIP 0.22UF	25V
C2079	1-164-004-11	CERAMIC CHIP 0.1UF	10.00% 25V	C3218	1-164-222-91	CERAMIC CHIP 0.22UF	25V
C2080	1-162-927-11	CERAMIC CHIP 100PF	5.00% 50V	C3219	1-164-222-91	CERAMIC CHIP 0.22UF	25V
C2081	1-162-928-11	CERAMIC CHIP 120PF	5.00% 50V	C3220	1-164-222-91	CERAMIC CHIP 0.22UF	25V
C2082	1-216-864-11	SHORT 0		C3221	1-164-222-91	CERAMIC CHIP 0.22UF	25V
C2083	1-162-964-11	CERAMIC CHIP 0.001UF	10.00% 50V	C3222	1-164-222-91	CERAMIC CHIP 0.22UF	25V
C2084	1-162-962-11	CERAMIC CHIP 470PF	10.00% 50V	C3223	1-164-222-91	CERAMIC CHIP 0.22UF	25V
C2085	1-163-021-91	CERAMIC CHIP 0.01UF	10.00% 50V	C3224	1-164-222-91	CERAMIC CHIP 0.22UF	25V
C2086	1-162-964-11	CERAMIC CHIP 0.001UF	10.00% 50V	C3225	1-164-222-91	CERAMIC CHIP 0.22UF	25V
C2087	1-163-021-91	CERAMIC CHIP 0.01UF	10.00% 50V	C3226	1-164-222-91	CERAMIC CHIP 0.22UF	25V
C2088	1-162-964-11	CERAMIC CHIP 0.001UF	10.00% 50V	C3227	1-164-222-91	CERAMIC CHIP 0.22UF	25V
C2089	1-162-962-11	CERAMIC CHIP 470PF	10.00% 50V	C3228	1-164-489-11	CERAMIC CHIP 0.22UF	10.00% 16V
C2090	1-126-947-11	ELECT 47UF	20.00% 25V	C3229	1-164-489-11	CERAMIC CHIP 0.22UF	10.00% 16V
C2091	1-126-947-11	ELECT 47UF	20.00% 25V	C3230	1-164-489-11	CERAMIC CHIP 0.22UF	10.00% 16V
C2092	1-126-947-11	ELECT 47UF	20.00% 25V	C3231	1-164-489-11	CERAMIC CHIP 0.22UF	10.00% 16V
C2093	1-126-947-11	ELECT 47UF	20.00% 25V	C3232	1-164-489-11	CERAMIC CHIP 0.22UF	10.00% 16V
C2094	1-126-947-11	ELECT 47UF	20.00% 25V	C3233	1-164-489-11	CERAMIC CHIP 0.22UF	10.00% 16V
C2095	1-126-947-11	ELECT 47UF	20.00% 25V	C3234	1-164-489-11	CERAMIC CHIP 0.22UF	10.00% 16V
C2096	1-162-970-11	CERAMIC CHIP 0.01UF	10.00% 25V	C3235	1-165-176-11	CERAMIC CHIP 0.047UF	10.00% 16V
C2500	1-126-952-11	ELECT 1000UF	20.00% 35V	C3236	1-165-176-11	CERAMIC CHIP 0.047UF	10.00% 16V
C2502	1-104-666-11	ELECT 220UF	20.00% 25V	C3237	1-165-176-11	CERAMIC CHIP 0.047UF	10.00% 16V
C2504	1-164-222-91	CERAMIC CHIP 0.22UF	25V	C3238	1-165-176-11	CERAMIC CHIP 0.047UF	10.00% 16V
C2505	1-115-339-11	CERAMIC CHIP 0.1UF	10.00% 50V	C3239	1-165-176-11	CERAMIC CHIP 0.047UF	10.00% 16V
C2506	1-126-972-11	ELECT 1000UF	20.00% 50V	C3240	1-165-176-11	CERAMIC CHIP 0.047UF	10.00% 16V
C2507	1-164-230-11	CERAMIC CHIP 220PF	5.00% 50V	C3241	1-126-933-11	ELECT 100UF	20.00% 16V
C2508	1-164-230-11	CERAMIC CHIP 220PF	5.00% 50V	C3242	1-162-970-11	CERAMIC CHIP 0.01UF	10.00% 25V
C2509	1-164-230-11	CERAMIC CHIP 220PF	5.00% 50V	C3243	1-164-222-91	CERAMIC CHIP 0.22UF	25V
C2510	1-164-227-11	CERAMIC CHIP 0.022UF	10.00% 25V	C3245	1-163-251-11	CERAMIC CHIP 100PF	5.00% 50V
C2511	1-163-021-91	CERAMIC CHIP 0.01UF	10.00% 50V	C3250	1-163-021-91	CERAMIC CHIP 0.01UF	10.00% 50V
C2512	1-163-021-91	CERAMIC CHIP 0.01UF	10.00% 50V	C3300	1-163-251-11	CERAMIC CHIP 100PF	5.00% 50V
C2513	1-126-952-11	ELECT 1000UF	20.00% 35V	C3309	1-126-964-11	ELECT 10UF	20.00% 50V
C2515	1-164-227-11	CERAMIC CHIP 0.022UF	10.00% 25V	C3310	1-164-222-91	CERAMIC CHIP 0.22UF	25V
C2516	1-126-953-11	ELECT 2200UF	20.00% 35V	C5103	1-126-960-11	ELECT 1UF	20.00% 50V
C2517	1-126-960-11	ELECT 1UF	20.00% 50V	C5106	1-126-933-11	ELECT 100UF	20.00% 16V
C2518	1-126-960-11	ELECT 1UF	20.00% 50V	C5109	1-126-964-11	ELECT 10UF	20.00% 50V
C2519	1-126-959-11	ELECT 0.47UF	20.00% 50V	C5110	1-126-947-11	ELECT 47UF	20.00% 25V
C2521	1-164-489-11	CERAMIC CHIP 0.22UF	10.00% 16V	C5111	1-126-964-11	ELECT 10UF	20.00% 50V
C2523	1-115-339-11	CERAMIC CHIP 0.1UF	10.00% 50V	C5112	1-126-964-11	ELECT 10UF	20.00% 50V
C3200	1-126-964-11	ELECT 10UF	20.00% 50V	C5114	1-164-156-11	CERAMIC CHIP 0.1UF	25V
C3202	1-126-964-11	ELECT 10UF	20.00% 50V	C5115	1-126-964-11	ELECT 10UF	20.00% 50V
C3203	1-126-964-11	ELECT 10UF	20.00% 50V	C5117	1-126-964-11	ELECT 10UF	20.00% 50V
C3206	1-126-964-11	ELECT 10UF	20.00% 50V	C5118	1-164-156-11	CERAMIC CHIP 0.1UF	25V
C3208	1-163-235-11	CERAMIC CHIP 22PF	5.00% 50V	C5119	1-107-823-11	CERAMIC CHIP 0.47UF	10.00% 16V
C3209	1-163-235-11	CERAMIC CHIP 22PF	5.00% 50V	C5120	1-165-176-11	CERAMIC CHIP 0.047UF	10.00% 16V
C3210	1-126-964-11	ELECT 10UF	20.00% 50V	C5121	1-165-176-11	CERAMIC CHIP 0.047UF	10.00% 16V

REF.NO.	PART.NO	DESCRIPTION	REMARK	REF.NO.	PART.NO	DESCRIPTION	REMARK
C5122	1-164-156-11	CERAMIC CHIP 0.1UF	25V	C5889	1-126-964-11	ELECT 10UF	20.00% 50V
C5123	1-126-964-11	ELECT 10UF	20.00% 50V	C5890	1-164-227-11	CERAMIC CHIP 0.022UF	10.00% 25V
C5124	1-164-156-11	CERAMIC CHIP 0.1UF	25V	C5891	1-137-581-11	FILM 0.1UF	5.00% 100V
C5125	1-126-964-11	ELECT 10UF	20.00% 50V	C5892	1-107-826-11	CERAMIC CHIP 0.1UF	10.00% 16V
C5300	1-126-933-11	ELECT 100UF	20.00% 16V	C5893	1-126-947-11	ELECT 47UF	20.00% 25V
C5301	1-126-947-11	ELECT 47UF	20.00% 25V	C5894	1-126-947-11	ELECT 47UF	20.00% 25V
C5302	1-164-222-91	CERAMIC CHIP 0.22UF	25V	C5895	1-164-156-11	CERAMIC CHIP 0.1UF	25V
C5303	1-136-153-00	FILM 0.01UF	5.00% 50V	C5896	1-165-176-11	CERAMIC CHIP 0.047UF	10.00% 16V
C5304	1-164-182-11	CERAMIC CHIP 0.0033UF	10.00% 50V	C5897	1-162-970-11	CERAMIC CHIP 0.01UF	10.00% 25V
C5305	1-165-176-11	CERAMIC CHIP 0.047UF	10.00% 16V	C5898	1-162-964-11	CERAMIC CHIP 0.001UF	10.00% 50V
C5306	1-164-156-11	CERAMIC CHIP 0.1UF	25V	C5899	1-107-823-11	CERAMIC CHIP 0.47UF	10.00% 16V
C5307	1-164-156-11	CERAMIC CHIP 0.1UF	25V	C6200	1-126-933-11	ELECT 100UF	20.00% 16V
C5309	1-162-927-11	CERAMIC CHIP 100PF	5.00% 50V	C6201	1-126-935-11	ELECT 470UF	20.00% 16V
C5310	1-136-165-00	FILM 0.1UF	5.00% 50V	C6202	1-126-933-11	ELECT 100UF	20.00% 16V
C5311	1-164-156-11	CERAMIC CHIP 0.1UF	25V	C6203	1-126-935-11	ELECT 470UF	20.00% 10V
C5312	1-165-176-11	CERAMIC CHIP 0.047UF	10.00% 16V	C6204	1-126-933-11	ELECT 100UF	20.00% 16V
C5313	1-107-714-11	ELECT 10UF	20.00% 50V	C6205	1-126-935-11	ELECT 470UF	20.00% 10V
C5314	1-162-970-11	CERAMIC CHIP 0.01UF	10.00% 25V	C6206	1-126-933-11	ELECT 100UF	20.00% 16V
C5316	1-164-230-11	CERAMIC CHIP 220PF	5.00% 50V	C6207	1-126-933-11	ELECT 100UF	20.00% 16V
C5318	1-164-156-11	CERAMIC CHIP 0.1UF	25V	C6208	1-126-933-11	ELECT 100UF	20.00% 16V
C5319	1-136-347-11	FILM 0.0047UF	5.00% 630V	C6209	1-126-933-11	ELECT 100UF	20.00% 16V
C5320	1-129-716-00	FILM 0.015UF	5.00% 630V	C6210	1-126-935-11	ELECT 470UF	20.00% 16V
C5321	1-136-347-11	FILM 0.0047UF	5.00% 630V	C6211	1-126-947-11	ELECT 47UF	20.00% 25V
C5322	1-164-156-11	CERAMIC CHIP 0.1UF	25V	C6212	1-126-933-11	ELECT 100UF	20.00% 16V
C5323	1-136-159-00	FILM 0.033UF	5.00% 50V	C6213	1-126-933-11	ELECT 100UF	20.00% 16V
C5400	1-126-964-11	ELECT 10UF	20.00% 50V	C6214	1-126-933-11	ELECT 100UF	20.00% 16V
C5401	1-107-714-11	ELECT 10UF	20.00% 50V	C7002	1-126-947-11	ELECT 47UF	20.00% 25V
C5403	1-128-527-11	ELECT 330UF	20.00% 25V	C7004	1-164-222-91	CERAMIC CHIP 0.22UF	25V
C5404	1-102-228-00	CERAMIC 470PF	10.00% 500V	C7008	1-162-919-11	CERAMIC CHIP 22PF	5.00% 50V
C5405	1-163-021-91	CERAMIC CHIP 0.01UF	10.00% 50V	C7016	1-107-823-11	CERAMIC CHIP 0.47UF	10.00% 16V
C5406	1-129-702-00	MYLAR 0.001UF	10.00% 400V	C7018	1-164-004-11	CERAMIC CHIP 0.1UF	10.00% 25V
C5407	1-128-527-11	ELECT 330UF	20.00% 25V	C7019	1-164-004-11	CERAMIC CHIP 0.1UF	10.00% 25V
C5409	1-126-968-11	ELECT 100UF	20.00% 50V	C7020	1-164-004-11	CERAMIC CHIP 0.1UF	10.00% 25V
C5410	1-163-021-91	CERAMIC CHIP 0.01UF	10.00% 50V	C7021	1-164-004-11	CERAMIC CHIP 0.1UF	10.00% 25V
C5411	1-137-401-11	MYLAR 0.22UF	10.00% 100V	C7022	1-164-004-11	CERAMIC CHIP 0.1UF	10.00% 25V
C5412	1-106-220-00	MYLAR 0.1UF	10.00% 100V	C7023	1-164-004-11	CERAMIC CHIP 0.1UF	10.00% 25V
C5413	1-130-785-11	MYLAR 0.47UF	10.00% 100V	C7030	1-164-004-11	CERAMIC CHIP 0.1UF	10.00% 25V
C5414	1-126-964-11	ELECT 10UF	20.00% 50V	C7031	1-164-004-11	CERAMIC CHIP 0.1UF	10.00% 25V
C5801	1-126-963-11	ELECT 4.7UF	20.00% 50V	C7032	1-164-004-11	CERAMIC CHIP 0.1UF	10.00% 25V
C5850	1-126-963-11	ELECT 4.7UF	20.00% 50V	C7038	1-107-823-11	CERAMIC CHIP 0.47UF	10.00% 16V
C5851	1-107-826-11	CERAMIC CHIP 0.1UF	10.00% 16V	C7039	1-162-966-11	CERAMIC CHIP 0.0022UF	10.00% 50V
C5853	1-162-970-11	CERAMIC CHIP 0.01UF	10.00% 25V	C7050	1-162-927-11	CERAMIC CHIP 100PF	5.00% 50V
C5854	1-107-826-11	CERAMIC CHIP 0.1UF	10.00% 16V	C7051	1-164-004-11	CERAMIC CHIP 0.1UF	10.00% 25V
C5858	1-107-826-11	CERAMIC CHIP 0.1UF	10.00% 16V	C7052	1-164-004-11	CERAMIC CHIP 0.1UF	10.00% 25V
C5859	1-126-960-11	ELECT 1UF	20.00% 50V	C7053	1-164-004-11	CERAMIC CHIP 0.1UF	10.00% 25V
C5860	1-165-176-11	CERAMIC CHIP 0.047UF	10.00% 16V	C7054	1-126-963-11	ELECT 4.7UF	20.00% 50V
C5868	1-164-004-11	CERAMIC CHIP 0.1UF	10.00% 25V	C7055	1-164-222-91	CERAMIC CHIP 0.22UF	25V
C5872	1-164-346-11	CERAMIC CHIP 1UF	16V	C7056	1-126-933-11	ELECT 100UF	20.00% 16V
C5873	1-163-251-11	CERAMIC CHIP 100PF	5.00% 50V	C7057	1-164-222-91	CERAMIC CHIP 0.22UF	25V
C5888	1-164-156-11	CERAMIC CHIP 0.1UF	25V	C7058	1-126-933-11	ELECT 100UF	20.00% 16V

REF.NO.	PART.NO	DESCRIPTION	REMARK	REF.NO.	PART.NO	DESCRIPTION	REMARK
C7059	1-126-933-11	ELECT	100UF	20.00%	16V		
C7060	1-164-222-91	CERAMIC CHIP	0.22UF		25V		
C7061	1-164-004-11	CERAMIC CHIP	0.1UF	10.00%	25V		
C7062	1-164-004-11	CERAMIC CHIP	0.1UF	10.00%	25V		
C7063	1-164-004-11	CERAMIC CHIP	0.1UF	10.00%	25V		
C7064	1-126-947-11	ELECT	47UF	20.00%	25V		
C7065	1-164-222-91	CERAMIC CHIP	0.22UF		25V		
C7067	1-126-947-11	ELECT	47UF	20.00%	25V		
C7068	1-164-222-91	CERAMIC CHIP	0.22UF		25V		
C7069	1-162-919-11	CERAMIC CHIP	22PF	5.00%	50V		
C7070	1-162-919-11	CERAMIC CHIP	22PF	5.00%	50V		
C7071	1-162-919-11	CERAMIC CHIP	22PF	5.00%	50V		
< CONNECTOR >							
CN0101	1-823-330-11	CONNECTOR, BOARD TO BOARD	40P				
CN0102	*1-564-520-11	PLUG, CONNECTOR	5P				
CN0103	*1-564-507-11	PLUG, CONNECTOR	4P				
CN1000	1-770-130-11	CONNECTOR (SQUARE TYPE)	21P				
CN1001	1-766-296-21	CONNECTOR, DUAL SCART					
CN2000	*1-564-512-11	PLUG, CONNECTOR	9P				
CN2500	*1-564-506-11	PLUG, CONNECTOR	3P				
CN2501	*1-564-507-11	PLUG, CONNECTOR	4P				
CN2502	*1-564-509-11	PLUG, CONNECTOR	6P				
CN5002	*1-564-510-11	PLUG, CONNECTOR	7P				
CN5100	*1-564-506-11	PLUG, CONNECTOR	3P				
CN5200	*1-564-506-11	PLUG, CONNECTOR	3P				
CN5801	*1-764-333-11	PLUG, CONNECTOR	10P				
CN6200	*1-564-507-11	PLUG, CONNECTOR	4P				
CN6202	*1-564-516-11	PLUG, CONNECTOR	13P				
CN6203	1-695-915-11	TAB (CONTACT)					
CN7000	*1-564-508-11	PLUG, CONNECTOR	5P				
CN7001	*1-564-512-11	PLUG, CONNECTOR	9P				
CN8001	1-766-281-11	PIN, CONNECTOR (PC BOARD)	8P				
< DIODE >							
D0101	8-719-921-88	DIODE	MTZJ-13B				
D0104	8-719-109-89	DIODE	RD5.6ESB2				
D0110	8-719-109-89	DIODE	RD5.6ESB2				
D0111	8-719-929-15	DIODE	HZS9.1NB2				
D0112	8-719-921-88	DIODE	MTZJ-13B				
D0113	8-719-921-88	DIODE	MTZJ-13B				
D1006	8-719-109-89	DIODE	RD5.6ESB2				
D2014	8-719-929-15	DIODE	HZS9.1NB2				
D2015	8-719-929-15	DIODE	HZS9.1NB2				
D2016	8-719-050-38	DIODE	M1MA152WK-T1				
D2018	8-719-929-15	DIODE	HZS9.1NB2				
D2019	8-719-929-15	DIODE	HZS9.1NB2				
D2500	8-719-050-38	DIODE	M1MA152WK-T1				
D2502	8-719-109-89	DIODE	RD5.6ESB2				
D2503	8-719-050-38	DIODE	M1MA152WK-T1				
D3001	8-719-929-15	DIODE	HZS9.1NB2				
D3003	8-719-929-15	DIODE	HZS9.1NB2				
D3005	8-719-929-15	DIODE	HZS9.1NB2				
D3007	8-719-109-89	DIODE	RD5.6ESB2				
D3008	8-719-109-89	DIODE	RD5.6ESB2				
D3009	8-719-929-15	DIODE	HZS9.1NB2				
D3011	8-719-929-15	DIODE	HZS9.1NB2				
D3013	8-719-929-15	DIODE	HZS9.1NB2				
D3015	8-719-929-15	DIODE	HZS9.1NB2				
D3017	8-719-109-89	DIODE	RD5.6ESB2				
D3018	8-719-109-89	DIODE	RD5.6ESB2				
D3019	8-719-929-15	DIODE	HZS9.1NB2				
D3021	8-719-929-15	DIODE	HZS9.1NB2				
D3023	8-719-109-89	DIODE	RD5.6ESB2				
D3024	8-719-929-15	DIODE	HZS9.1NB2				
D3026	8-719-929-15	DIODE	HZS9.1NB2				
D3028	8-719-929-15	DIODE	HZS9.1NB2				
D3201	8-719-109-89	DIODE	RD5.6ESB2				
D5101	8-719-050-38	DIODE	M1MA152WK-T1				
D5103	8-719-110-88	DIODE	RD39ES-B2				
D5104	8-719-109-89	DIODE	RD5.6ESB2				
D5300	8-719-081-97	DIODE	MMDL914T1				
D5303	8-719-081-97	DIODE	MMDL914T1				
D5304	8-719-081-97	DIODE	MMDL914T1				
D5305	8-719-991-33	DIODE	1SS133T-77				
D5306	8-719-302-43	DIODE	EL1Z				
D5307	8-719-987-87	DIODE	ERA82-009				
D5309	8-719-081-97	DIODE	MMDL914T1				
D5310	8-719-081-97	DIODE	MMDL914T1				
D5400	8-719-982-03	DIODE	MTZJ-3.6A				
D5401	8-719-050-38	DIODE	M1MA152WK-T1				
D5404	8-719-110-41	DIODE	RD15ES-B2				
D5405	8-719-908-03	DIODE	GP08D				
D5406	8-719-081-97	DIODE	MMDL914T1				
D5407	8-719-081-97	DIODE	MMDL914T1				
D5804	8-719-109-89	DIODE	RD5.6ESB2				
D5807	8-719-929-15	DIODE	HZS9.1NB2				
D5809	8-719-050-38	DIODE	M1MA152WK-T1				
D5811	8-719-081-97	DIODE	MMDL914T1				
D5812	8-719-081-97	DIODE	MMDL914T1				
D5813	8-719-081-97	DIODE	MMDL914T1				
D6200	8-719-063-70	DIODE	D1NL20U				
D7004	8-719-929-15	DIODE	HZS9.1NB2				
D7006	1-216-809-11	RES-CHIP	100 5% 1/10W				
< FERRITE BEAD >							
FB3001	1-414-760-21	FERRITE	0UH				

Note : The components identified by shading and marked Δ are critical for safety. Replace only with the part numbers specified in the parts list.

A

REF.NO.	PART.NO	DESCRIPTION	REMARK	REF.NO.	PART.NO	DESCRIPTION	REMARK
	< FILTER >			L3008	1-216-295-91	SHORT	0
FL2000	1-239-803-11	FILTER, EMI		L3009	1-216-295-91	SHORT	0
	< IC >			L3010	1-216-295-91	SHORT	0
IC2000	6-701-031-01	IC MSP3411G-QA-B10		L3011	1-216-295-91	SHORT	0
IC2001	8-759-100-96	IC UPC4558G2		L3012	1-216-295-91	SHORT	0
IC2500	8-759-831-56	IC TDA7497		L3200	1-412-006-31	INDUCTOR	10UH
IC3200	6-700-505-01	IC VSP9402A-A32GEG		L3202	1-412-006-31	INDUCTOR	10UH
IC5102	8-759-325-48	IC CA0005AD		L3203	1-412-006-31	INDUCTOR	10UH
IC5103	8-752-072-94	IC CXA1875AM-T4		L3206	1-412-006-31	INDUCTOR	10UH
IC5104	8-759-803-42	IC LA6500-FA		L3208	1-412-006-31	INDUCTOR	10UH
IC5300	8-759-008-70	IC LM358N		L3300	1-412-006-31	INDUCTOR	10UH
IC5301	8-759-450-95	IC LM393N		L5300	1-406-989-21	INDUCTOR	10MH
IC5302	8-759-450-95	IC LM393N		L5301	1-406-989-21	INDUCTOR	10MH
IC5400	8-759-696-71	IC STV9379A		L5400	1-412-524-11	INDUCTOR	8.2UH
IC6200	8-759-648-19	IC L7809CV/LSY		L5896	1-216-864-11	SHORT	0
IC6201	8-759-648-20	IC L7805CV/LSY		L5897	1-216-864-11	SHORT	0
IC6202	8-759-445-59	IC BA033T		L5898	1-414-934-21	INDUCTOR	10UH
IC6203	8-759-098-24	IC PQ30RV11		L5899	1-414-934-21	INDUCTOR	10UH
IC6204	8-759-591-02	IC L78L33ABZ-AP		L7001	1-414-934-21	INDUCTOR	10UH
IC6205	8-759-394-35	IC BA12T		L7009	1-414-934-21	INDUCTOR	10UH
IC6206	8-759-991-41	IC LM78L05ACZ		L7010	1-414-934-21	INDUCTOR	10UH
IC7002	8-752-090-88	IC CXA2100AQ-TL		L7011	1-414-934-21	INDUCTOR	10UH
	< JACK >			L7012	1-414-934-21	INDUCTOR	10UH
J2000	1-784-632-11	JACK, PIN 2P		< IC LINK >			
	< COIL >			PS2501	Δ 1-533-597-31	LINK, IC	5A
L1000	1-412-987-31	INDUCTOR	4.7UH	< TRANSISTOR >			
L1001	1-412-987-31	INDUCTOR	4.7UH	Q1000	8-729-010-05	TRANSISTOR	MSE709-RT1
L1002	1-414-934-21	INDUCTOR	10UH	Q1001	8-729-010-29	TRANSISTOR	MSD601-RST1
L1003	1-414-934-21	INDUCTOR	10UH	Q1004	8-729-010-05	TRANSISTOR	MSE709-RT1
L1005	1-414-934-21	INDUCTOR	10UH	Q1005	8-729-421-19	TRANSISTOR	UN2213
L2000	1-414-934-21	INDUCTOR	10UH	Q1006	8-729-010-05	TRANSISTOR	MSE709-RT1
L2001	1-414-934-21	INDUCTOR	10UH	Q2000	8-729-010-29	TRANSISTOR	MSD601-RST1
L2007	1-535-143-61	LEAD, JUMPER	(5.0MM)	Q2001	8-729-010-29	TRANSISTOR	MSD601-RST1
L2008	1-216-295-91	SHORT	0	Q2002	8-729-010-29	TRANSISTOR	MSD601-RST1
L2009	1-216-295-91	SHORT	0	Q2003	8-729-010-29	TRANSISTOR	MSD601-RST1
L2010	1-414-928-21	INDUCTOR	1UH	Q2004	8-729-010-29	TRANSISTOR	MSD601-RST1
L2012	1-414-934-21	INDUCTOR	10UH	Q2005	8-729-010-29	TRANSISTOR	MSD601-RST1
L2014	1-408-602-31	INDUCTOR	8.2UH	Q2501	8-729-010-29	TRANSISTOR	MSD601-RST1
L2500	1-535-143-61	LEAD, JUMPER	(5.0MM)	Q2502	8-729-010-29	TRANSISTOR	MSD601-RST1
L2501	1-535-143-61	LEAD, JUMPER	(5.0MM)	Q2503	8-729-010-29	TRANSISTOR	MSD601-RST1
L3000	1-216-295-91	SHORT	0	Q2504	8-729-010-05	TRANSISTOR	MSE709-RT1
L3004	1-216-295-91	SHORT	0	Q3200	8-729-010-29	TRANSISTOR	MSD601-RST1
L3005	1-216-295-91	SHORT	0	Q3201	8-729-010-29	TRANSISTOR	MSD601-RST1
L3006	1-216-295-91	SHORT	0	Q3202	8-729-010-05	TRANSISTOR	MSE709-RT1
L3007	1-216-295-91	SHORT	0	Q3204	8-729-010-05	TRANSISTOR	MSE709-RT1
				Q3300	8-729-010-29	TRANSISTOR	MSD601-RST1
				Q3301	8-729-010-05	TRANSISTOR	MSE709-RT1

REF.NO.	PART.NO	DESCRIPTION	REMARK	REF.NO.	PART.NO	DESCRIPTION	REMARK
Q3302	8-729-010-05	TRANSISTOR MSB709-RT1		R1005	1-216-049-11	RES-CHIP 1K 5%	1/10W
Q3500	8-729-028-28	TRANSISTOR 2SK2036 (TE85L)		R1006	1-216-051-00	RES-CHIP 1.2K 5%	1/10W
Q3501	8-729-028-28	TRANSISTOR 2SK2036 (TE85L)		R1007	1-414-813-11	FERRITE 00H	
Q5100	8-729-010-05	TRANSISTOR MSB709-RT1		R1008	1-216-295-91	SHORT 0	
Q5101	8-729-010-29	TRANSISTOR MSD601-RST1		R1009	1-216-295-91	SHORT 0	
Q5300	8-729-010-29	TRANSISTOR MSD601-RST1		R1010	1-216-295-91	SHORT 0	
Q5301	8-729-053-33	TRANSISTOR IRF614-037		R1017	1-216-822-11	RES-CHIP 1.2K 5%	1/10W
Q5302	8-729-140-97	TRANSISTOR 2SB734-34		R1019	1-216-295-91	SHORT 0	
Q5303	8-729-010-29	TRANSISTOR MSD601-RST1		R1021	1-216-833-11	RES-CHIP 10K 5%	1/10W
Q5304	8-729-010-29	TRANSISTOR MSD601-RST1		R1022	1-216-839-11	RES-CHIP 33K 5%	1/10W
Q5305	8-729-119-78	TRANSISTOR 2SC2785-HFE		R1023	1-216-849-11	RES-CHIP 220K 5%	1/10W
Q5306	8-729-140-97	TRANSISTOR 2SB734-34		R1024	1-216-839-11	RES-CHIP 33K 5%	1/10W
Q5307	8-729-010-05	TRANSISTOR MSB709-RT1		R1025	1-216-837-11	RES-CHIP 22K 5%	1/10W
Q5400	8-729-010-29	TRANSISTOR MSD601-RST1		R1026	1-216-817-11	RES-CHIP 470 5%	1/10W
Q5401	8-729-421-19	TRANSISTOR UN2213		R2009	1-216-817-11	RES-CHIP 470 5%	1/10W
Q5402	8-729-010-05	TRANSISTOR MSB709-RT1		R2010	1-216-817-11	RES-CHIP 470 5%	1/10W
Q5403	8-729-421-19	TRANSISTOR UN2213		R2011	1-216-049-11	RES-CHIP 1K 5%	1/10W
Q5404	8-729-926-76	TRANSISTOR IRF620		R2014	1-216-049-11	RES-CHIP 1K 5%	1/10W
Q5813	8-729-421-19	TRANSISTOR UN2213		R2015	1-216-295-91	SHORT 0	
Q5814	8-729-010-05	TRANSISTOR MSB709-RT1		R2017	1-216-853-11	RES-CHIP 470K 5%	1/10W
Q5815	8-729-010-29	TRANSISTOR MSD601-RST1		R2018	1-216-295-91	SHORT 0	
Q5816	8-729-010-05	TRANSISTOR MSB709-RT1		R2020	1-216-853-11	RES-CHIP 470K 5%	1/10W
Q6201	8-729-140-97	TRANSISTOR 2SB734-34		R2023	1-216-853-11	RES-CHIP 470K 5%	1/10W
Q7003	8-729-010-29	TRANSISTOR MSD601-RST1		R2026	1-216-853-11	RES-CHIP 470K 5%	1/10W
Q7009	8-729-010-05	TRANSISTOR MSB709-RT1		R2029	1-216-853-11	RES-CHIP 470K 5%	1/10W
Q7011	8-729-010-05	TRANSISTOR MSB709-RT1		R2032	1-216-853-11	RES-CHIP 470K 5%	1/10W
Q7012	8-729-010-05	TRANSISTOR MSB709-RT1		R2035	1-216-853-11	RES-CHIP 470K 5%	1/10W
Q7013	8-729-010-29	TRANSISTOR MSD601-RST1		R2038	1-216-853-11	RES-CHIP 470K 5%	1/10W
Q7014	8-729-010-05	TRANSISTOR MSB709-RT1		R2041	1-216-853-11	RES-CHIP 470K 5%	1/10W
Q7015	8-729-010-05	TRANSISTOR MSB709-RT1		R2042	1-216-829-11	RES-CHIP 4.7K 5%	1/10W
Q7016	8-729-010-29	TRANSISTOR MSD601-RST1		R2043	1-216-829-11	RES-CHIP 4.7K 5%	1/10W
Q7017	8-729-010-05	TRANSISTOR MSB709-RT1		R2044	1-216-853-11	RES-CHIP 470K 5%	1/10W
Q7018	8-729-010-05	TRANSISTOR MSB709-RT1		R2047	1-216-853-11	RES-CHIP 470K 5%	1/10W
Q7019	8-729-010-29	TRANSISTOR MSD601-RST1		R2048	1-216-837-11	RES-CHIP 22K 5%	1/10W
				R2050	1-216-845-11	RES-CHIP 100K 5%	1/10W
		< RESISTOR >		R2051	1-216-049-11	RES-CHIP 1K 5%	1/10W
JR121	1-216-864-11	SHORT 0		R2052	1-216-837-11	RES-CHIP 22K 5%	1/10W
JR123	1-216-864-11	SHORT 0		R2053	1-216-864-11	SHORT 0	
JR2000	1-216-295-91	SHORT 0		R2054	1-216-049-11	RES-CHIP 1K 5%	1/10W
				R2055	1-216-049-11	RES-CHIP 1K 5%	1/10W
R0101	1-216-833-11	RES-CHIP 10K 5%	1/10W	R2056	1-216-037-00	RES-CHIP 330 5%	1/10W
R0102	1-216-827-11	RES-CHIP 3.3K 5%	1/10W	R2057	1-216-025-11	RES-CHIP 100 5%	1/10W
R0103	1-216-073-91	RES-CHIP 10K 5%	1/10W	R2058	1-216-025-11	RES-CHIP 100 5%	1/10W
R0105	1-216-025-11	RES-CHIP 100 5%	1/10W	R2059	1-216-829-11	RES-CHIP 4.7K 5%	1/10W
R0107	1-216-025-11	RES-CHIP 100 5%	1/10W	R2060	1-216-829-11	RES-CHIP 4.7K 5%	1/10W
R1000	1-216-049-11	RES-CHIP 1K 5%	1/10W	R2061	1-216-829-11	RES-CHIP 4.7K 5%	1/10W
R1001	1-216-001-00	RES-CHIP 10 5%	1/10W	R2062	1-216-829-11	RES-CHIP 4.7K 5%	1/10W
R1002	1-216-821-11	RES-CHIP 1K 5%	1/10W	R2063	1-216-829-11	RES-CHIP 4.7K 5%	1/10W
R1003	1-216-809-11	RES-CHIP 100 5%	1/10W	R2064	1-249-425-11	CARBON 4.7K 5%	1/4W
R1004	1-216-809-11	RES-CHIP 100 5%	1/10W	R2065	1-216-837-11	RES-CHIP 22K 5%	1/10W

REF.NO.	PART.NO	DESCRIPTION	REMARK	REF.NO.	PART.NO	DESCRIPTION	REMARK
R2066	1-216-829-11	RES-CHIP	4.7K 5% 1/10W	R2924	1-216-295-91	SHORT	0
R2067	1-216-829-11	RES-CHIP	4.7K 5% 1/10W	R2927	1-216-295-91	SHORT	0
R2068	1-216-049-11	RES-CHIP	1K 5% 1/10W	R2930	1-216-295-91	SHORT	0
R2069	1-216-837-11	RES-CHIP	22K 5% 1/10W	R2933	1-216-295-91	SHORT	0
R2070	1-216-833-11	RES-CHIP	10K 5% 1/10W	R2936	1-216-295-91	SHORT	0
R2071	1-216-839-11	RES-CHIP	33K 5% 1/10W	R2939	1-216-295-91	SHORT	0
R2072	1-216-049-11	RES-CHIP	1K 5% 1/10W	R2942	1-216-295-91	SHORT	0
R2073	1-216-049-11	RES-CHIP	1K 5% 1/10W	R2945	1-216-295-91	SHORT	0
R2074	1-216-837-11	RES-CHIP	22K 5% 1/10W	R3000	1-216-025-11	RES-CHIP	100 5% 1/10W
R2075	1-216-833-11	RES-CHIP	10K 5% 1/10W	R3001	1-216-022-00	RES-CHIP	75 5% 1/10W
R2076	1-216-839-11	RES-CHIP	33K 5% 1/10W	R3009	1-216-025-11	RES-CHIP	100 5% 1/10W
R2077	1-216-049-11	RES-CHIP	1K 5% 1/10W	R3010	1-216-022-00	RES-CHIP	75 5% 1/10W
R2078	1-216-025-11	RES-CHIP	100 5% 1/10W	R3011	1-216-025-11	RES-CHIP	100 5% 1/10W
R2079	1-216-049-11	RES-CHIP	1K 5% 1/10W	R3012	1-216-022-00	RES-CHIP	75 5% 1/10W
R2080	1-218-867-11	RES-CHIP	6.8K 5% 1/10W	R3013	1-216-025-11	RES-CHIP	100 5% 1/10W
R2081	1-216-833-11	RES-CHIP	10K 5% 1/10W	R3014	1-216-022-00	RES-CHIP	75 5% 1/10W
R2082	1-216-805-11	RES-CHIP	47 5% 1/10W	R3015	1-216-022-00	RES-CHIP	75 5% 1/10W
R2083	1-216-817-11	RES-CHIP	470 5% 1/10W	R3016	1-216-025-11	RES-CHIP	100 5% 1/10W
R2084	1-216-837-11	RES-CHIP	22K 5% 1/10W	R3017	1-216-022-00	RES-CHIP	75 5% 1/10W
R2085	1-216-837-11	RES-CHIP	22K 5% 1/10W	R3018	1-216-025-11	RES-CHIP	100 5% 1/10W
R2086	1-216-837-11	RES-CHIP	22K 5% 1/10W	R3019	1-216-022-00	RES-CHIP	75 5% 1/10W
R2087	1-216-837-11	RES-CHIP	22K 5% 1/10W	R3020	1-216-025-11	RES-CHIP	100 5% 1/10W
R2088	1-216-041-00	RES-CHIP	470 5% 1/10W	R3021	1-216-022-00	RES-CHIP	75 5% 1/10W
R2089	1-216-041-00	RES-CHIP	470 5% 1/10W	R3022	1-216-025-11	RES-CHIP	100 5% 1/10W
R2092	1-216-039-00	RES-CHIP	390 5% 1/10W	R3023	1-216-022-00	RES-CHIP	75 5% 1/10W
R2093	1-216-039-00	RES-CHIP	390 5% 1/10W	R3024	1-216-025-11	RES-CHIP	100 5% 1/10W
R2094	1-216-039-00	RES-CHIP	390 5% 1/10W	R3025	1-216-022-00	RES-CHIP	75 5% 1/10W
R2095	1-216-039-00	RES-CHIP	390 5% 1/10W	R3026	1-216-022-00	RES-CHIP	75 5% 1/10W
R2096	1-216-039-00	RES-CHIP	390 5% 1/10W	R3027	1-216-025-11	RES-CHIP	100 5% 1/10W
R2097	1-216-039-00	RES-CHIP	390 5% 1/10W	R3028	1-216-022-00	RES-CHIP	75 5% 1/10W
R2098	1-216-049-11	RES-CHIP	1K 5% 1/10W	R3029	1-216-045-00	RES-CHIP	680 5% 1/10W
R2099	1-216-049-11	RES-CHIP	1K 5% 1/10W	R3030	1-216-022-00	RES-CHIP	75 5% 1/10W
R2500	1-216-073-91	RES-CHIP	10K 5% 1/10W	R3031	1-216-022-00	RES-CHIP	75 5% 1/10W
R2501	1-216-341-11	METAL OXIDE	0.22 5% 1W	R3032	1-216-022-00	RES-CHIP	75 5% 1/10W
R2502	1-208-810-11	METAL CHIP	15K 0.5% 1/10W	R3033	1-216-025-11	RES-CHIP	100 5% 1/10W
R2503	1-208-810-11	METAL CHIP	15K 0.5% 1/10W	R3034	1-216-022-00	RES-CHIP	75 5% 1/10W
R2504	1-216-049-11	RES-CHIP	1K 5% 1/10W	R3035	1-216-025-11	RES-CHIP	100 5% 1/10W
R2507	1-216-837-11	RES-CHIP	22K 5% 1/10W	R3036	1-216-022-00	RES-CHIP	75 5% 1/10W
R2509	1-249-417-11	CARBON	1K 5% 1/4W	R3037	1-216-045-00	RES-CHIP	680 5% 1/10W
R2511	1-216-073-91	RES-CHIP	10K 5% 1/10W	R3218	1-216-821-11	RES-CHIP	1K 5% 1/10W
R2516	1-216-081-00	RES-CHIP	22K 5% 1/10W	R3219	1-216-821-11	RES-CHIP	1K 5% 1/10W
R2517	1-216-841-11	RES-CHIP	47K 5% 1/10W	R3220	1-216-837-11	RES-CHIP	22K 5% 1/10W
R2518	1-216-049-11	RES-CHIP	1K 5% 1/10W	R3221	1-216-837-11	RES-CHIP	22K 5% 1/10W
R2519	1-216-833-11	RES-CHIP	10K 5% 1/10W	R3222	1-216-837-11	RES-CHIP	22K 5% 1/10W
R2520	1-216-025-11	RES-CHIP	100 5% 1/10W	R3223	1-216-837-11	RES-CHIP	22K 5% 1/10W
R2524	1-216-833-11	RES-CHIP	10K 5% 1/10W	R3225	1-216-025-11	RES-CHIP	100 5% 1/10W
R2525	1-216-828-11	RES-CHIP	3.9K 5% 1/10W	R3226	1-216-025-11	RES-CHIP	100 5% 1/10W
R2912	1-216-295-91	SHORT	0	R3229	1-216-025-11	RES-CHIP	100 5% 1/10W
R2914	1-216-853-11	RES-CHIP	470K 5% 1/10W	R3233	1-216-821-11	RES-CHIP	1K 5% 1/10W
R2921	1-216-295-91	SHORT	0	R3234	1-216-821-11	RES-CHIP	1K 5% 1/10W

REF.NO.	PART.NO	DESCRIPTION	REMARK	REF.NO.	PART.NO	DESCRIPTION	REMARK
R3235	1-216-822-11	RES-CHIP	1.2K 5% 1/10W	R5156	1-216-833-11	RES-CHIP	10K 5% 1/10W
R3236	1-216-822-11	RES-CHIP	1.2K 5% 1/10W	R5157	1-216-829-11	RES-CHIP	4.7K 5% 1/10W
R3237	1-216-797-11	RES-CHIP	10 5% 1/10W	R5300	1-208-806-11	METAL CHIP	10K 0.5% 1/10W
R3238	1-216-797-11	RES-CHIP	10 5% 1/10W	R5301	1-216-829-11	RES-CHIP	4.7K 5% 1/10W
R3305	1-216-025-11	RES-CHIP	100 5% 1/10W	R5302	1-208-806-11	METAL CHIP	10K 0.5% 1/10W
R3306	1-216-025-11	RES-CHIP	100 5% 1/10W	R5304	1-208-806-11	METAL CHIP	10K 0.5% 1/10W
R3312	1-216-825-11	RES-CHIP	2.2K 5% 1/10W	R5305	1-208-852-11	METAL CHIP	820K 0.5% 1/10W
R3313	1-216-825-11	RES-CHIP	2.2K 5% 1/10W	R5307	1-216-041-00	RES-CHIP	470 5% 1/10W
R3318	1-216-025-11	RES-CHIP	100 5% 1/10W	R5308	1-216-295-91	SHORT	0
R3319	1-216-025-11	RES-CHIP	100 5% 1/10W	R5309	1-208-824-11	METAL CHIP	56K 0.5% 1/10W
R3320	1-216-025-11	RES-CHIP	100 5% 1/10W	R5310	1-208-830-11	METAL CHIP	100K 0.5% 1/10W
R3321	1-216-864-11	SHORT	0	R5311	1-216-045-00	RES-CHIP	680 5% 1/10W
R3322	1-216-864-11	SHORT	0	R5312	1-208-832-11	METAL CHIP	120K 0.5% 1/10W
R3323	1-216-813-11	RES-CHIP	220 5% 1/10W	R5314	1-208-840-11	METAL CHIP	270K 0.5% 1/10W
R3403	1-216-821-11	RES-CHIP	1K 5% 1/10W	R5315	1-216-043-91	RES-CHIP	560 5% 1/10W
R3500	1-216-834-11	RES-CHIP	12K 5% 1/10W	R5316	1-216-057-00	RES-CHIP	2.2K 5% 1/10W
R3501	1-216-834-11	RES-CHIP	12K 5% 1/10W	R5317	1-216-845-11	RES-CHIP	100K 5% 1/10W
R3504	1-216-825-11	RES-CHIP	2.2K 5% 1/10W	R5318	1-208-806-11	METAL CHIP	10K 0.5% 1/10W
R3505	1-216-825-11	RES-CHIP	2.2K 5% 1/10W	R5319	1-208-840-11	METAL CHIP	270K 0.5% 1/10W
R3603	1-216-295-91	SHORT	0	R5320	1-216-833-11	RES-CHIP	10K 5% 1/10W
R5102	1-208-814-91	METAL CHIP	22K 0.5% 1/10W	R5321	1-216-837-11	RES-CHIP	22K 5% 1/10W
R5103	1-216-637-11	METAL CHIP	270 0.5% 1/10W	R5322	1-216-820-11	RES-CHIP	820 5% 1/10W
R5107	1-208-814-91	METAL CHIP	22K 0.5% 1/10W	R5324	1-208-810-11	METAL CHIP	15K 0.5% 1/10W
R5111	1-208-814-91	METAL CHIP	22K 0.5% 1/10W	R5325	1-208-812-11	METAL CHIP	18K 0.5% 1/10W
R5112	1-216-679-11	METAL CHIP	15K 0.5% 1/10W	R5326	1-216-845-11	RES-CHIP	100K 5% 1/10W
R5118	1-249-411-11	CARBON	330 5% 1/4W	R5328	1-216-033-00	RES-CHIP	220 5% 1/10W
R5119	1-216-844-11	RES-CHIP	82K 5% 1/10W	R5331	1-216-033-00	RES-CHIP	220 5% 1/10W
R5122	1-216-821-11	RES-CHIP	1K 5% 1/10W	R5332	1-208-806-11	METAL CHIP	10K 0.5% 1/10W
R5125	1-216-836-11	RES-CHIP	18K 5% 1/10W	R5333	1-208-820-11	METAL CHIP	39K 0.5% 1/10W
R5126	1-249-406-11	CARBON	120 5% 1/4W	R5334	1-208-834-11	METAL CHIP	150K 0.5% 1/10W
R5127	1-216-025-11	RES-CHIP	100 5% 1/10W	R5335	1-208-818-11	METAL CHIP	33K 0.5% 1/10W
R5128	1-216-809-11	RES-CHIP	100 5% 1/10W	R5336	1-216-057-00	RES-CHIP	2.2K 5% 1/10W
R5129	1-216-809-11	RES-CHIP	100 5% 1/10W	R5337	1-218-867-11	RES-CHIP	6.8K 5% 1/10W
R5130	1-216-809-11	RES-CHIP	100 5% 1/10W	R5340	1-216-057-00	RES-CHIP	2.2K 5% 1/10W
R5131	1-216-821-11	RES-CHIP	1K 5% 1/10W	R5341	1-216-089-91	RES-CHIP	47K 5% 1/10W
R5132	1-216-809-11	RES-CHIP	100 5% 1/10W	R5342	1-208-818-11	METAL CHIP	33K 0.5% 1/10W
R5133	1-216-809-11	RES-CHIP	100 5% 1/10W	R5343	1-208-808-11	METAL CHIP	12K 0.5% 1/10W
R5137	1-216-809-11	RES-CHIP	100 5% 1/10W	R5344	1-208-820-11	METAL CHIP	39K 0.5% 1/10W
R5138	1-216-809-11	RES-CHIP	100 5% 1/10W	R5345	1-208-832-11	METAL CHIP	120K 0.5% 1/10W
R5139	1-216-821-11	RES-CHIP	1K 5% 1/10W	R5346	1-216-849-11	RES-CHIP	220K 5% 1/10W
R5140	1-216-821-11	RES-CHIP	1K 5% 1/10W	R5347	1-216-833-11	RES-CHIP	10K 5% 1/10W
R5146	1-216-025-11	RES-CHIP	100 5% 1/10W	R5349	1-216-043-91	RES-CHIP	560 5% 1/10W
R5148	1-216-809-11	RES-CHIP	100 5% 1/10W	R5350	1-216-041-00	RES-CHIP	470 5% 1/10W
R5149	1-216-637-11	METAL CHIP	270 0.5% 1/10W	R5351	1-216-809-11	RES-CHIP	100 5% 1/10W
R5150	1-249-414-11	CARBON	560 5% 1/4W	R5352	1-216-821-11	RES-CHIP	1K 5% 1/10W
R5151	1-249-454-11	CARBON	3.9 5% 1/4W	R5401	1-216-837-11	RES-CHIP	22K 5% 1/10W
R5152	1-249-413-11	CARBON	470 5% 1/4W	R5402	1-216-081-00	RES-CHIP	22K 5% 1/10W
R5153	1-249-393-11	CARBON	10 5% 1/4W	R5403	1-216-829-11	RES-CHIP	4.7K 5% 1/10W
R5154	1-216-833-11	RES-CHIP	10K 5% 1/10W	R5404	1-216-829-11	RES-CHIP	4.7K 5% 1/10W
R5155	1-249-421-11	CARBON	2.2K 5% 1/4W	R5405	1-216-829-11	RES-CHIP	4.7K 5% 1/10W

REF.NO.	PART.NO	DESCRIPTION	REMARK	REF.NO.	PART.NO	DESCRIPTION	REMARK
R5408	1-216-825-11	RES-CHIP	2.2K 5% 1/10W	R7056	1-218-867-11	RES-CHIP	6.8K 5% 1/10W
R5409	1-208-802-11	METAL CHIP	6.8K 0.5% 1/10W	R7057	1-216-842-11	RES-CHIP	56K 5% 1/10W
R5410	1-208-798-11	METAL CHIP	4.7K 0.5% 1/10W	R7058	1-216-049-11	RES-CHIP	1K 5% 1/10W
R5411	1-216-061-91	RES-CHIP	3.3K 5% 1/10W	R7065	1-216-821-11	RES-CHIP	1K 5% 1/10W
R5413	1-208-802-11	METAL CHIP	6.8K 0.5% 1/10W	R7066	1-216-809-11	RES-CHIP	100 5% 1/10W
R5414	1-249-383-11	CARBON	1.5 5% 1/4W	R7068	1-216-681-11	METAL CHIP	18K 0.5% 1/10W
R5415	1-249-389-11	CARBON	4.7 5% 1/4W	R7070	1-216-817-11	RES-CHIP	470 5% 1/10W
R5416	1-215-888-00	METAL OXIDE	220 5% 2W	R7071	1-216-817-11	RES-CHIP	470 5% 1/10W
R5417	1-208-798-11	METAL CHIP	4.7K 0.5% 1/10W	R7072	1-216-817-11	RES-CHIP	470 5% 1/10W
R5420	1-214-798-21	METAL	1.8 1% 1/2W	R7073	1-216-041-00	RES-CHIP	470 5% 1/10W
R5421	1-214-798-21	METAL	1.8 1% 1/2W	R7074	1-216-043-91	RES-CHIP	560 5% 1/10W
R5803	1-216-861-11	RES-CHIP	2.2M 5% 1/10W	R7075	1-216-817-11	RES-CHIP	470 5% 1/10W
R5804	1-216-049-11	RES-CHIP	1K 5% 1/10W	R7076	1-216-041-00	RES-CHIP	470 5% 1/10W
R5805	1-216-049-11	RES-CHIP	1K 5% 1/10W	R7077	1-216-043-91	RES-CHIP	560 5% 1/10W
R5806	1-216-089-91	RES-CHIP	47K 5% 1/10W	R7078	1-216-817-11	RES-CHIP	470 5% 1/10W
R5807	1-216-049-11	RES-CHIP	1K 5% 1/10W	R7079	1-216-041-00	RES-CHIP	470 5% 1/10W
R5808	1-216-049-11	RES-CHIP	1K 5% 1/10W	R7080	1-216-043-91	RES-CHIP	560 5% 1/10W
R5809	1-216-073-91	RES-CHIP	10K 5% 1/10W	R7081	1-216-817-11	RES-CHIP	470 5% 1/10W
R5865	1-216-841-11	RES-CHIP	47K 5% 1/10W	R7082	1-208-782-11	METAL CHIP	1K 0.5% 1/10W
R5869	1-216-817-11	RES-CHIP	470 5% 1/10W	R7088	1-208-783-11	METAL CHIP	1.1K 0.5% 1/10W
R5871	1-216-850-11	RES-CHIP	270K 5% 1/10W	R7089	1-216-819-11	RES-CHIP	680 5% 1/10W
R5875	1-216-825-11	RES-CHIP	2.2K 5% 1/10W	R7090	1-216-819-11	RES-CHIP	680 5% 1/10W
R5877	1-216-821-91	RES-CHIP	1K 5% 1/10W	R7091	1-216-819-11	RES-CHIP	680 5% 1/10W
R5879	1-216-809-11	RES-CHIP	100 5% 1/10W	R7092	1-216-295-91	SHORT	0
R5880	1-216-809-11	RES-CHIP	100 5% 1/10W	R7093	1-216-295-91	SHORT	0
R5881	1-216-833-11	RES-CHIP	10K 5% 1/10W	R7094	1-216-295-91	SHORT	0
R5882	1-216-833-11	RES-CHIP	10K 5% 1/10W	R7095	1-216-295-91	SHORT	0
R5884	1-216-841-11	RES-CHIP	47K 5% 1/10W	R7096	1-216-803-11	RES-CHIP	33 5% 1/10W
R5885	1-216-809-11	RES-CHIP	100 5% 1/10W	R7097	1-216-803-11	RES-CHIP	33 5% 1/10W
R5887	1-216-809-11	RES-CHIP	100 5% 1/10W	R7098	1-216-803-11	RES-CHIP	33 5% 1/10W
R5888	1-216-809-11	RES-CHIP	100 5% 1/10W	< CRYSTAL >			
R5889	1-208-806-11	METAL CHIP	10K 0.5% 1/10W	X2000	1-760-628-11	VIBRATOR, CRYSTAL	
R5892	1-216-833-11	RES-CHIP	10K 5% 1/10W	X3200	1-781-946-21	VIBRATOR, CRYSTAL	
R5895	1-216-833-11	RES-CHIP	10K 5% 1/10W	X5800	1-767-127-11	VIBRATOR, CERAMIC	
R5898	1-216-832-11	RES-CHIP	8.2K 5% 1/10W	A Board Variant Parts KV-28LS60B			
R5899	1-216-863-11	RES-CHIP	3.3M 5% 1/10W	< CAPACITOR >			
R6200	1-216-635-11	METAL CHIP	220 0.5% 1/10W	C1011	1-163-253-11	CERAMIC CHIP	120PF 5% 50V
R6201	1-216-643-11	METAL CHIP	470 0.5% 1/10W	C1012	1-163-245-11	CERAMIC CHIP	56PF 5% 50V
R6202	1-249-395-11	CARBON	15 5% 1/4W	C1016	1-162-915-11	CERAMIC CHIP	10PF 0.50PF 50V
R7007	1-216-049-11	RES-CHIP	1K 5% 1/10W	C1017	1-163-247-91	CERAMIC CHIP	68PF 5% 50V
R7018	1-216-025-11	RES-CHIP	100 5% 1/10W	< COIL >			
R7023	1-216-834-11	RES-CHIP	12K 5% 1/10W	L1004	1-412-751-11	INDUCTOR	18UH
R7034	1-216-025-11	RES-CHIP	100 5% 1/10W	< TRANSISTOR >			
R7035	1-216-025-11	RES-CHIP	100 5% 1/10W	Q1002	8-729-010-29	TRANSISTOR MSD601-RST1	
R7048	1-216-025-11	RES-CHIP	100 5% 1/10W	Q1003	8-729-900-53	TRANSISTOR DTC114EK	
R7050	1-216-833-11	RES-CHIP	10K 5% 1/10W				
R7051	1-216-025-11	RES-CHIP	100 5% 1/10W				
R7052	1-216-025-11	RES-CHIP	100 5% 1/10W				
R7053	1-216-049-11	RES-CHIP	1K 5% 1/10W				
R7054	1-216-847-11	RES-CHIP	150K 5% 1/10W				

REF.NO.	PART.NO	DESCRIPTION	REMARK	REF.NO.	PART.NO	DESCRIPTION	REMARK
< RESISTOR >				R5878	1-216-820-91	RES-CHIP 820 5%	1/10W
R1011	1-216-815-11	RES-CHIP	330 5% 1/10W	R5883	1-216-861-91	RES-CHIP 2.2M 5%	1/10W
R1012	1-216-815-11	RES-CHIP	330 5% 1/10W	< TUNER >			
R1014	NOT FITTED			TU1000	8-598-533-01	FRONT END BTF-EC411	
R1015	1-216-817-11	RES-CHIP	470 5% 1/10W	A Board Variant Parts KV-28LS60U			
R1016	1-216-809-11	RES-CHIP	100 5% 1/10W	< CAPACITOR >			
R1018	1-216-825-11	RES-CHIP	2.2K 5% 1/10W	C1011	NOT FITTED		
R1020	1-216-295-91	SHORT	0	C1012	NOT FITTED		
R5303	1-208-824-11	METAL CHIP	56K 0.5% 1/10W	C1016	NOT FITTED		
R5306	1-208-802-11	METAL CHIP	6.8K 0.5% 1/10W	C1017	NOT FITTED		
R5327	1-216-474-11	METAL OXIDE	82 5% 3W	< COIL >			
R5338	1-249-417-11	CARBON	1K 5% 1/4W	L1004	NOT FITTED		
R5400	1-216-848-11	RES-CHIP	180K 5% 1/10W	< TRANSISTOR >			
R5407	1-216-854-11	RES-CHIP	560K 5% 1/10W	Q1002	NOT FITTED		
R5878	1-216-820-91	RES-CHIP	820 5% 1/10W	Q1003	NOT FITTED		
R5883	1-216-861-91	RES-CHIP	2.2M 5% 1/10W	< RESISTOR >			
< TUNER >				R1011	NOT FITTED		
TU1000	8-598-535-01	FRONT END BTF-EF411		R1012	NOT FITTED		
A Board Variant Parts KV-28LS60E				R1014	1-216-295-91	SHORT	0
< CAPACITOR >				R1015	NOT FITTED		
C1011	NOT FITTED			R1016	NOT FITTED		
C1012	NOT FITTED			R1018	NOT FITTED		
C1016	NOT FITTED			R1020	NOT FITTED		
C1017	NOT FITTED			R5303	1-208-824-11	METAL CHIP	56K 0.5% 1/10W
< COIL >				R5306	1-208-802-11	METAL CHIP	6.8K 0.5% 1/10W
L1004	NOT FITTED			R5327	1-216-474-11	METAL OXIDE	82 5% 3W
< TRANSISTOR >				R5338	1-249-417-11	CARBON	1K 5% 1/4W
Q1002	NOT FITTED			R5400	1-216-848-11	RES-CHIP	180K 5% 1/10W
Q1003	NOT FITTED			R5407	1-216-854-11	RES-CHIP	560K 5% 1/10W
< RESISTOR >				R5878	1-216-820-91	RES-CHIP	820 5% 1/10W
R1011	NOT FITTED			R5883	1-216-861-91	RES-CHIP	2.2M 5% 1/10W
R1012	NOT FITTED			< TUNER >			
R1014	1-216-295-91	SHORT	0	TU1000	8-598-529-01	FRONT END BTF-EU611	
R1015	NOT FITTED			A Board Variant Parts KV-32LS60B			
R1016	NOT FITTED			< CAPACITOR >			
R1018	NOT FITTED			C1011	1-163-253-11	CERAMIC CHIP	120PF 5% 50V
R1020	NOT FITTED			C1012	1-163-245-11	CERAMIC CHIP	56PF 5% 50V
R5303	1-208-824-11	METAL CHIP	56K 0.5% 1/10W	C1016	1-162-915-11	CERAMIC CHIP	10PF 0.50PF 50V
R5306	1-208-802-11	METAL CHIP	6.8K 0.5% 1/10W	C1017	1-163-247-91	CERAMIC CHIP	68PF 5% 50V
R5327	1-216-474-11	METAL OXIDE	82 5% 3W				
R5338	1-249-417-11	CARBON	1K 5% 1/4W				
R5400	1-216-848-11	RES-CHIP	180K 5% 1/10W				
R5407	1-216-854-11	RES-CHIP	560K 5% 1/10W				

REF.NO.	PART.NO	DESCRIPTION	REMARK	REF.NO.	PART.NO	DESCRIPTION	REMARK
		< COIL >					
L1004	1-412-751-11	INDUCTOR	18UH	R1018		NOT FITTED	
		< TRANSISTOR >		R1020		NOT FITTED	
Q1002	8-729-010-29	TRANSISTOR MSD601-RST1		R5303	1-216-685-11	METAL CHIP	27K 0.5% 1/10W
Q1003	8-729-900-53	TRANSISTOR DTC114EK		R5306	1-208-803-11	METAL CHIP	7.5K 0.5% 1/10W
		< RESISTOR >		R5327	1-216-474-11	METAL OXIDE	39 5% 3W
R1011	1-216-815-11	RES-CHIP	330 5% 1/10W	R5338	1-249-413-11	CARBON	470 5% 1/4W
R1012	1-216-815-11	RES-CHIP	330 5% 1/10W	R5400	1-216-849-11	RES-CHIP	220K 5% 1/10W
R1014		NOT FITTED		R5407	1-216-857-11	RES-CHIP	1M 5% 1/10W
R1015	1-216-817-11	RES-CHIP	470 5% 1/10W	R5878	1-216-049-11	RES-CHIP	1K 5% 1/10W
R1016	1-216-809-11	RES-CHIP	100 5% 1/10W	R5883	1-216-855-11	RES-CHIP	680K 5% 1/10W
		< TUNER >					
TU1000	8-598-535-01	FRONT END BTF-EF411		TU1000	8-598-533-01	FRONT END BTF-EC411	
A Board Variant Parts KV-32LS60E/32LS60K				A Board Variant Parts KV-32LS60U			
		< CAPACITOR >					
C1011		NOT FITTED		C1011		NOT FITTED	
C1012		NOT FITTED		C1012		NOT FITTED	
C1016		NOT FITTED		C1016		NOT FITTED	
C1017		NOT FITTED		C1017		NOT FITTED	
		< COIL >					
L1004		NOT FITTED		L1004		NOT FITTED	
		< TRANSISTOR >					
Q1002		NOT FITTED		Q1002		NOT FITTED	
Q1003		NOT FITTED		Q1003		NOT FITTED	
		< RESISTOR >					
R1011		NOT FITTED		R1011		NOT FITTED	
R1012		NOT FITTED		R1012		NOT FITTED	
R1014	1-216-295-91	SHORT	0	R1014	1-216-295-91	SHORT	0
R1015		NOT FITTED		R1015		NOT FITTED	
R1016		NOT FITTED		R1016		NOT FITTED	
		< COIL >					
L1004		NOT FITTED		R1018		NOT FITTED	
		< TRANSISTOR >		R1020		NOT FITTED	
Q1002		NOT FITTED		R5303	1-216-685-11	METAL CHIP	27K 0.5% 1/10W
Q1003		NOT FITTED		R5306	1-208-803-11	METAL CHIP	7.5K 0.5% 1/10W
		< RESISTOR >		R5327	1-216-474-11	METAL OXIDE	39 5% 3W
R1011		NOT FITTED		R5338	1-249-413-11	CARBON	470 5% 1/4W
R1012		NOT FITTED		R5400	1-216-849-11	RES-CHIP	220K 5% 1/10W
R1014	1-216-295-91	SHORT	0	R5407	1-216-857-11	RES-CHIP	1M 5% 1/10W
R1015		NOT FITTED		R5878	1-216-049-11	RES-CHIP	1K 5% 1/10W
R1016		NOT FITTED		R5883	1-216-855-11	RES-CHIP	680K 5% 1/10W
		< TUNER >					
TU1000	8-598-529-01	FRONT END BTF-EU611		TU1000	8-598-529-01	FRONT END BTF-EU611	

Note : The components identified by shading and marked Δ are critical for safety. Replace only with the part numbers specified in the parts list.

F2

C

REF.NO.	PART.NO	DESCRIPTION	REMARK	REF.NO.	PART.NO	DESCRIPTION	REMARK
*A-1624-102-A F2 Board, Complete				C7325	1-162-909-11	CERAMIC CHIP 4PF	0.25PF 50V
	4-206-220-01	HOLDER, LED		C7326	1-163-009-91	CERAMIC CHIP 0.001UF	10.00% 50V
	*4-374-846-01	COVER, CAPACITOR, CAP TYPE		C7330	1-136-207-11	MYLAR 0.047UF	10.00% 400V
	< CAPACITOR >			C7331	1-162-909-11	CERAMIC CHIP 4PF	0.25PF 50V
C0982	1-104-665-11	ELECT 100UF	20.00% 25V	C7333	1-163-035-00	CERAMIC CHIP 0.047UF	50V
C0983	1-102-114-00	CERAMIC 470PF	10.00% 50V	C7334	1-163-247-91	CERAMIC CHIP 68PF	5.00% 50V
C0984	1-102-129-00	CERAMIC 0.01UF	10.00% 50V	C7350	1-126-947-11	ELECT 47UF	20.00% 25V
C6981	Δ 1-113-924-11	CERAMIC 0.0047UF	20.00% 250V	C7351	1-162-909-11	CERAMIC CHIP 4PF	0.25PF 50V
	< CONNECTOR >			C7352	1-163-009-91	CERAMIC CHIP 0.001UF	10.00% 50V
CN0981	*1-564-507-11	PLUG, CONNECTOR 4P		C7354	1-126-933-11	ELECT 100UF	20.00% 16V
CN6981	Δ *1-580-844-11	PIN, CONNECTOR (POWER)		C7355	1-107-967-11	ELECT 1UF	20.00% 400V
CN6982	Δ *1-695-292-11	PIN, CONNECTOR (POWER)		C7356	1-136-207-11	MYLAR 0.047UF	10.00% 400V
CN6983	Δ 1-695-915-11	TAB (CONTACT)		C7358	1-162-909-11	CERAMIC CHIP 4PF	0.25PF 50V
	< DIODE >			C7359	1-163-035-00	CERAMIC CHIP 0.047UF	50V
D0981	8-719-109-89	DIODE MTZJ-T-77-5.6B		C7360	1-163-247-91	CERAMIC CHIP 68PF	5.00% 50V
D0983	8-719-082-12	DIODE TLHK5190		C7378	1-162-116-00	CERAMIC 680PF	10.00% 2KV
	< FUSE >			C7379	1-162-114-00	CERAMIC 0.0047UF	2KV
F6981	Δ 1-576-232-11	FUSE (H.B.C.) 5A/250V		C7380	1-107-662-11	ELECT 22UF	20.00% 250V
	Δ 1-533-725-11	HOLDER, FUSE (F6981)		C7384	1-162-911-11	CERAMIC CHIP 6PF	0.50PF 50V
	< IC >			C7385	1-162-913-11	CERAMIC CHIP 8PF	0.50PF 50V
IC0981	8-742-180-30	HYB IC SBX3081-51(20)		C7387	1-162-911-11	CERAMIC CHIP 6PF	0.50PF 50V
	< RESISTOR >			C7388	1-162-913-11	CERAMIC CHIP 8PF	0.50PF 50V
R0982	1-247-807-31	CARBON 100 5% 1/4W		C7390	1-162-911-11	CERAMIC CHIP 6PF	0.50PF 50V
R6981	Δ 1-202-719-00	SOLID 1M 10% 1/2W		C7391	1-162-913-11	CERAMIC CHIP 8PF	0.50PF 50V
	< SWITCH >			< CONNECTOR >			
S6981	Δ 1-571-433-21	SWITCH, PUSH (AC POWER)		CN7300	*1-564-508-11	PLUG, CONNECTOR 5P	
	< VARISTOR >			CN7301	*1-564-512-11	PLUG, CONNECTOR 9P	
VD6981	Δ 1-803-830-31	VARISTOR (ERZV14D621)		CN7311	1-695-915-11	TAB (CONTACT)	
	< IC >			CN7333	1-695-915-11	TAB (CONTACT)	
*A-1638-158-A C Board, Complete				< DIODE >			
	4-382-854-01	SCREW (M3X8), P, SW (+)		D7300	8-719-911-19	DIODE 1SS119-25TD	
	< CAPACITOR >			D7325	8-719-911-19	DIODE 1SS119-25TD	
C7303	1-162-909-11	CERAMIC CHIP 4PF	0.25PF 50V	D7350	8-719-911-19	DIODE 1SS119-25TD	
C7305	1-136-207-11	MYLAR 0.047UF	10.00% 400V	D7375	8-719-991-33	DIODE 1SS133T-77	
C7306	1-163-009-91	CERAMIC CHIP 0.001UF	10.00% 50V	D7376	8-719-991-33	DIODE 1SS133T-77	
C7308	1-162-909-11	CERAMIC CHIP 4PF	0.25PF 50V	D7378	8-719-109-89	DIODE MTZJ-T-77-5.6B	
C7309	1-163-035-00	CERAMIC CHIP 0.047UF	50V	D7379	8-719-109-89	DIODE MTZJ-T-77-5.6B	
C7310	1-163-247-91	CERAMIC CHIP 68PF	5.00% 50V	< IC >			
	< SOCKET >			IC7300	8-759-360-83	IC TDA6111Q/N4	
				IC7325	8-759-360-83	IC TDA6111Q/N4	
				IC7350	8-759-360-83	IC TDA6111Q/N4	
				< SOCKET >			
				J7375	Δ 1-251-732-11	SOCKET, CRT	

Note : The components identified by shading and marked Δ are critical for safety. Replace only with the part numbers specified in the parts list.

C

H2

REF.NO.	PART.NO	DESCRIPTION	REMARK	REF.NO.	PART.NO	DESCRIPTION	REMARK
	< COIL >						
L7375	1-410-671-31	INDUCTOR	47UH	R7391	1-216-824-11	RES-CHIP	1.8K 5% 1/10W
L7376	Δ 1-532-637-00	LINK, IC 1A/150V		R7392	1-216-819-11	RES-CHIP	680 5% 1/10W
L7378	1-414-934-21	INDUCTOR	10UH	R7393	1-216-823-11	RES-CHIP	1.5K 5% 1/10W
	< TRANSISTOR >			R7394	1-249-417-11	CARBON	1K 5% 1/4W
Q7350	8-729-901-06	TRANSISTOR MUN2113T1		R7395	1-216-824-11	RES-CHIP	1.8K 5% 1/10W
Q7352	8-729-421-19	TRANSISTOR MUN2213T1		R7396	1-216-819-11	RES-CHIP	680 5% 1/10W
Q7353	8-729-421-19	TRANSISTOR MUN2213T1		R7397	1-216-823-11	RES-CHIP	1.5K 5% 1/10W
Q7354	8-729-901-06	TRANSISTOR MUN2113T1		R7398	1-249-417-11	CARBON	1K 5% 1/4W
Q7355	8-729-421-19	TRANSISTOR MUN2213T1		R7399	1-216-824-11	RES-CHIP	1.8K 5% 1/10W
	< RESISTOR >				< VARIABLE RESISTOR >		
R7300	1-249-417-11	CARBON	1K 5% 1/4W	RV7375	1-225-952-11	RES, ADJ, METAL FILM 110M	
R7303	1-216-824-11	RES-CHIP	1.8K 5% 1/10W		*A-1647-043-A H2 Board, Complete		
R7304	1-260-095-11	SOLID	470 20% 1/2W		< CAPACITOR >		
R7305	1-215-903-11	METAL OXIDE	68K 5% 2W	C2906	1-126-960-11	ELECT	1UF 20.00% 50V
R7306	1-535-143-61	LEAD, JUMPER (5.0MM)		C2907	1-126-960-11	ELECT	1UF 20.00% 50V
R7309	1-216-824-11	RES-CHIP	1.8K 5% 1/10W	C2913	1-162-964-11	CERAMIC CHIP	0.001UF 10.00% 50V
R7310	1-216-819-11	RES-CHIP	680 5% 1/10W	C2914	1-162-964-11	CERAMIC CHIP	0.001UF 10.00% 50V
R7325	1-249-417-11	CARBON	1K 5% 1/4W		< CONNECTOR >		
R7328	1-216-824-11	RES-CHIP	1.8K 5% 1/10W	CN2900	1-779-947-11	TERMINAL BLOCK, S	
R7329	1-260-095-11	SOLID	470 20% 1/2W	CN2906	*1-564-524-11	PLUG, CONNECTOR 9P	
R7330	1-215-903-11	METAL OXIDE	68K 5% 2W	CN2908	1-564-521-11	PLUG, CONNECTOR 6P	
R7331	1-535-143-61	LEAD, JUMPER (5.0MM)			< JACK >		
R7334	1-216-819-11	RES-CHIP	680 5% 1/10W	J2900	1-750-264-11	JACK	
R7335	1-216-824-11	RES-CHIP	1.8K 5% 1/10W		< COIL >		
R7350	1-249-417-11	CARBON	1K 5% 1/4W	L0904	1-535-143-61	LEAD, JUMPER (5.0MM)	
R7356	1-216-824-11	RES-CHIP	1.8K 5% 1/10W	L2900	1-535-143-61	LEAD, JUMPER (5.0MM)	
R7357	1-260-095-11	SOLID	470 20% 1/2W	L2901	1-535-143-61	LEAD, JUMPER (5.0MM)	
R7358	1-215-903-11	METAL OXIDE	68K 5% 2W	L2902	1-535-143-61	LEAD, JUMPER (5.0MM)	
R7363	1-216-819-11	RES-CHIP	680 5% 1/10W	L2903	1-535-143-61	LEAD, JUMPER (5.0MM)	
R7364	1-216-824-11	RES-CHIP	1.8K 5% 1/10W		< RESISTOR >		
R7373	1-216-823-11	RES-CHIP	1.5K 5% 1/10W	R912	1-535-143-61	LEAD, JUMPER (5.0MM)	
R7374	1-216-819-11	RES-CHIP	680 5% 1/10W	R0901	1-249-427-11	CARBON	6.8K 5% 1/4W
R7375	1-249-435-11	CARBON	33K 5% 1/4W	R0902	1-215-445-00	METAL	10K 1% 1/4W
R7376	1-249-429-11	CARBON	10K 5% 1/4W	R0911	1-249-419-11	CARBON	1.5K 5% 1/4W
R7377	1-249-430-11	CARBON	12K 5% 1/4W	R0913	1-247-843-11	CARBON	3.3K 5% 1/4W
R7379	1-216-833-11	RES-CHIP	10K 5% 1/10W	R0914	1-249-431-11	CARBON	15K 5% 1/4W
R7380	1-216-833-11	RES-CHIP	10K 5% 1/10W	R2903	1-249-406-11	CARBON	120 5% 1/4W
R7381	1-216-833-11	RES-CHIP	10K 5% 1/10W	R2904	1-249-406-11	CARBON	120 5% 1/4W
R7382	1-202-549-00	SOLID	100 20% 1/2W	R2909	1-247-895-91	CARBON	470K 5% 1/4W
R7383	1-216-342-51	FILM	0.27 5% 1W	R2910	1-247-895-91	CARBON	470K 5% 1/4W
R7384	1-216-399-00	METAL OXIDE	6.8 5% 3W	R2915	1-249-406-11	CARBON	120 5% 1/4W
R7385	1-202-549-00	SOLID	100 20% 1/2W	R2916	1-249-406-11	CARBON	120 5% 1/4W
R7387	1-247-735-11	SOLID	47 20% 1/2W	R2917	1-249-412-11	CARBON	390 5% 1/4W
R7388	1-535-143-51	LEAD, JUMPER (20.0MM)					
R7389	1-247-881-00	CARBON	120K 5% 1/4W				
R7390	1-249-417-11	CARBON	1K 5% 1/4W				

REF.NO.	PART.NO	DESCRIPTION	REMARK	REF.NO.	PART.NO	DESCRIPTION	REMARK
R2918	1-249-412-11	CARBON 390 5%	1/4W	L7402	1-414-934-21	INDUCTOR 10UH	
	< SWITCH >			L7403	1-414-934-21	INDUCTOR 10UH	
S0900	1-692-979-11	SWITCH, TACTILE			< TRANSISTOR >		
S0901	1-692-979-11	SWITCH, TACTILE		Q7400	8-729-010-29	TRANSISTOR MSD601-RST1	
S0902	1-692-979-11	SWITCH, TACTILE		Q7401	8-729-010-29	TRANSISTOR MSD601-RST1	
*A-1644-119-A VM Board, Complete				Q7402	8-729-010-29	TRANSISTOR MSD601-RST1	
	4-382-854-01	SCREW (M3X8), P, SW (+)		Q7403	8-729-119-78	TRANSISTOR 2SC2785-HFE	
	< CAPACITOR >			Q7404	8-729-216-22	TRANSISTOR 2SA1162-G	
C7401	1-126-935-11	ELECT 470UF	20.00% 16V	Q7405	8-729-026-39	TRANSISTOR 2SA933AS-QT	
C7403	1-126-935-11	ELECT 470UF	20.00% 6.3V	Q7406	8-729-045-05	TRANSISTOR 2SA2005	
C7404	1-115-339-11	CERAMIC CHIP 0.1UF	10.00% 50V	Q7407	8-729-045-04	TRANSISTOR 2SC5511	
C7405	1-126-933-11	ELECT 100UF	20.00% 16V	Q7408	8-729-216-22	TRANSISTOR 2SA1037K-T-146-R	
C7406	1-126-935-11	ELECT 470UF	20.00% 6.3V	Q7409	8-729-010-29	TRANSISTOR MSD601-RST1	
C7407	1-107-364-11	MYLAR 0.01UF	10.00% 200V		< RESISTOR >		
C7408	1-107-364-11	MYLAR 0.01UF	10.00% 200V	R7400	1-216-017-91	RES-CHIP 47 5%	1/10W
C7409	1-107-649-11	ELECT 2.2UF	20.00% 250V	R7401	1-216-061-91	RES-CHIP 3.3K 5%	1/10W
C7410	1-130-471-00	MYLAR 0.001UF	5.00% 50V	R7402	1-216-041-00	RES-CHIP 470 5%	1/10W
C7411	1-130-471-00	MYLAR 0.001UF	5.00% 50V	R7403	1-249-393-11	CARBON 10 5%	1/4W
C7412	1-126-935-11	ELECT 470UF	20.00% 16V	R7404	1-249-413-11	CARBON 470 5%	1/4W
C7413	1-126-935-11	ELECT 470UF	20.00% 16V	R7405	1-216-065-91	RES-CHIP 4.7K 5%	1/10W
C7414	1-107-652-11	ELECT 10UF	20.00% 250V	R7407	1-249-411-11	CARBON 330 5%	1/4W
C7415	1-107-363-91	MYLAR 0.0068UF	10.00% 200V	R7409	1-216-029-00	RES-CHIP 150 5%	1/10W
C7418	1-163-021-91	CERAMIC CHIP 0.01UF	10.00% 50V	R7410	1-216-017-91	RES-CHIP 47 5%	1/10W
C7421	1-163-251-11	CERAMIC CHIP 100PF	5.00% 50V	R7411	1-216-017-91	RES-CHIP 47 5%	1/10W
	< CONNECTOR >			R7412	1-216-017-91	RES-CHIP 47 5%	1/10W
CN7442	*1-564-508-11	PLUG, CONNECTOR 5P		R7413	1-249-414-11	CARBON 560 5%	1/4W
CN7443	*1-564-506-11	PLUG, CONNECTOR 3P		R7414	1-249-432-11	CARBON 18K 5%	1/4W
CN7444	*1-770-723-11	CONNECTOR, BOARD TO BOARD 8P		R7415	1-247-739-11	CARBON 100 5%	1/2W
	< DIODE >			R7416	1-249-389-11	CARBON 4.7 5%	1/4W
D7400	8-719-991-33	DIODE 1SS133T-77		R7417	1-249-432-11	CARBON 18K 5%	1/4W
D7401	8-719-991-33	DIODE 1SS133T-77		R7418	1-249-414-11	CARBON 560 5%	1/4W
D7402	1-535-143-61	LEAD, JUMPER (5.0MM)		R7419	1-249-421-11	CARBON 2.2K 5%	1/4W
D7403	8-719-991-33	DIODE 1SS133T-77		R7420	1-249-421-11	CARBON 2.2K 5%	1/4W
D7404	8-719-991-33	DIODE 1SS133T-77		R7421	1-249-389-11	CARBON 4.7 5%	1/4W
D7405	8-719-924-11	DIODE MTZJ-T-77-22		R7422	1-249-405-11	CARBON 100 5%	1/4W
D7406	8-719-924-11	DIODE MTZJ-T-77-22		R7423	1-215-915-11	METAL OXIDE 470 5%	3W
	< FERRITE BEAD >			R7427	1-216-025-11	RES-CHIP 100 5%	1/10W
FB7400	1-535-143-61	LEAD, JUMPER (5.0MM)		R7428	1-216-033-00	RES-CHIP 220 5%	1/10W
FB7401	1-535-143-61	LEAD, JUMPER (5.0MM)		R7429	1-216-033-00	RES-CHIP 220 5%	1/10W
	< COIL >			R7432	1-216-065-91	RES-CHIP 4.7K 5%	1/10W
L7400	1-414-934-21	INDUCTOR 10UH		R7433	1-249-395-11	CARBON 15 5%	1/4W
				R7434	1-249-395-11	CARBON 15 5%	1/4W
				R7435	1-216-033-00	RES-CHIP 220 5%	1/10W
				R7436	1-216-049-11	RES-CHIP 1K 5%	1/10W

Note : The components identified by shading and marked Δ are critical for safety. Replace only with the part numbers specified in the parts list.

REF.NO.	PART.NO	DESCRIPTION	REMARK	REF.NO.	PART.NO	DESCRIPTION	REMARK
MISCELLANEOUS				REMOTE COMMANDER			
Δ	1-571-433-21	SWITCH PUSH (AC POWER)					
Δ	1-823-853-11	CORD, POWER (KV-28LS60B/28LS60E/32LS60B/ KV-32LS60E/32LS60K)					
Δ	1-776-860-12	POWER CORD, FILTER (UK) (KV-28LS60U/32LS60U)					
	1-424-855-11	COIL, CHOKE 29MMH					
	8-598-535-11	FRONTEND BTF-EF411 (KV-28LS60B/32LS60B)					
	8-598-533-01	FRONTEND BTF-EC411 (KV-28LS60E/32LS60E /32LS60K)					
	8-598-529-01	FRONTEND BTF-EU611 (KV-28LS60U/32LS60U)					
Δ	1-453-383-21	TRANSFORMER ASSY, FLYBACK (NX-4522//Z214) (KV-28LS60)					
Δ	1-453-340-31	TRANSFORMER ASSY, FLYBACK (NX-4522//Z2B4) (KV-32LS60)					
	1-529-408-11	SPEAKER (4.2x24CM)					
	1-529-989-11	SPEAKER (8CM)					
Δ	8-451-521-11	DEFLECTION YOKE (Y28RVC3-B) (KV-28LS60)					
Δ	1-451-480-11	DEFLECTION YOKE (Y32RVC2) (KV-32LS60)					
	1-419-363-11	COIL, NA ROTATION (RT200)					
	8-453-011-11	NECK ASSY, (NA299-M)					
Δ	1-424-886-11	COIL, DEGAUSSING (KV-28LS60)					
Δ	1-424-888-11	COIL, DEGAUSSING (KV-32LS60)					
Δ	1-251-946-21	CAP ASSY, HIGH-VOLTAGE (KV-28LS60)					
Δ	1-251-374-32	CAP ASSY, HIGH-VOLTAGE (KV-32LS60)					
Δ	8-735-099-05	PICTURE TUBE (W66LLX060X) (KV-28LS60)					
Δ	8-735-079-05	PICTURE TUBE (W76LLZ060X) (KV-32LS60)					
	1-452-094-00	MAGNET, ROTATABLE DISK; 15MM					
	1-452-032-00	MAGNET, DISK; 10MM					
ACCESSORIES AND PACKAGING MATERIALS							
	*4-029-168-01	BAG, PROTECTION					
	*4-205-939-01	INDIVIDUAL CARTON (KV-28LS60)					
	*4-206-691-01	INDIVIDUAL CARTON (KV-32LS60)					
	4-206-694-21	INSTRUCTION MANUAL (KV-28LS60B/32LS60B) (GERMAN/FRENCH/ITALIAN/DUTCH)					
	4-206-694-61	INSTRUCTION MANUAL (KV-28LS60E/32LS60E) (ITALIAN)					
	4-206-694-51	INSTRUCTION MANUAL (KV-28LS60E/32LS60E) (DANISH/SPANISH/NORWEGIAN/PORTUGUESE/ SWEDISH/FINNISH)					
	4-206-694-11	INSTRUCTION MANUAL (KV-28LS60E/32LS60E) (GERMAN/GREEK/TURKISH)					
	4-206-694-31	INSTRUCTION MANUAL (KV-32LS60K) (BULGARIAN/CZECH/ENGLISH/HUNGARIAN POLISH/RUSSIAN)					
	4-206-694-41	INSTRUCTION MANUAL (KV-28LS60U/32LS60U) (ENGLISH)					

TRACE

A new TV Repair Assistance Tool that combines ease of use and powerful PC software tools to allow you to save valuable time during many TV repairs.



The TRACE interface connects to the PC's serial port. It provides connection to the TV's I²C bus and can be provided with an InfraRed transmitter (optional).

The interface is powered by a standard 9 V PP3 battery for portable use, and can also be powered by an external 9V/25mA DC power supply.

The TRACE software that is supplied with the interface allows you to:

- Read, restore and compare NVM contents via the I²C bus
- Acknowledge check of all I²C devices in the TV set
- Read Error Codes (emulation of the Error Reader tool)

With the optional IR Add-on kit, the following features can be added:

- Remote Commander emulation
- User programmable Functional Check through Infrared
- Fast and documented Test Mode setting of all Sony TV chassis

Additional features such as Adjustments and Troubleshooting are available in chassis-dependent software modules. Please contact your local Sony Service organisation for the latest information.

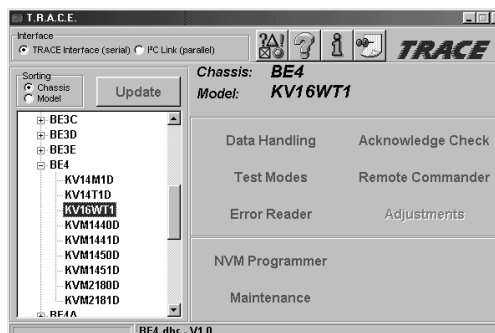

Note: For workshops already using the existing I²C Link parallel port interface (9-948-320-30), this software can be used as well, replacing the TV Data Handling software (9-948-340-50), but Error Reader and IR functions can only be accessed with the TRACE interface.

Partnumbers: TRACE Starter Kit (TRACE interface + software): 9-948-320-70
TRACE Software (for users of the I²C Link interface): 9-948-340-80
TRACE IR Add-on (IR interface + Remote Commander software): 9-948-320-80

PC requirements: IBM-compatible PC with operating system Windows95, Windows98, or WindowsNT*.

* WindowsNT only supported with TRACE interface